



# Application Guide 2023

Sports Exhausts | Universal Exhaust Parts | Catalytic Converters









**J**etex Exhaust Systems are the sports alternative to the original exhaust system. Jetex produce exhausts of the highest quality, offering improved performance, a sporty sound and design. Car manufacturers usually develop standard exhaust systems that are suited to the average driver. Generally, this means an exhaust that is not optimised for performance and an exhaust note lacking character or feel. Jetex exhausts are constructed for the driver who demands a little bit more from their car. A Jetex exhaust will realise the hidden potential of the engine, resulting in a car that performs, sounds and looks fantastic.

### Higher performance and engine efficiency

Lower back pressure contributes to improved engine performance and efficiency. By using pipe work with larger diameters and straight through silencers, the back pressure of a Jetex exhaust is lower compared to the original exhaust. Generally, this means an increase of performance up to 2-6%. If the engine has been tuned/mapped, then the increase in performance can be substantially higher.

### Quality and material

Jetex exhausts are made to EU approval standards and are constructed to be durable under normal and higher stress driving conditions. Pipework and silencer walls are made of extra strong and tough material, with extra support provided at critical points throughout the exhaust system. Stainless steel packing is used where needed, to prevent silencer burnout. Aluminised material, stainless-chromium steel and stainless steel are used to counteract corrosion. Tailpipes are always made of polished stainless steel (T304).

All part numbers denoted "Top Quality" are made of chromium stainless steel (T400 series). Flanges, clamps and other fitting parts may not be made from stainless steel.

All part numbers denoted "SS Quality", have exterior surfaces made from stainless steel (T300 series). Flanges, clamps and other fitting parts may not be made from stainless steel.

### Sporty sound

Jetex exhausts use "straight through" silencers in order to minimize back pressure as much as possible. This type of silencer construction is good at absorbing high frequencies, but lower frequencies are not absorbed in the same way. This results in a low and "sporty" sound, which often differs from the original exhaust sound. However, the overall sound level is similar to the original, while following EU regulations for the car model in question. Our "T" systems have the first silencer/resonator removed. The inclusion of a racepipe is an ideal option for customers that have tuned/chipped their engine, or who want a louder exhaust note. Jetex accept no responsibility with regards the volume of exhaust note as these modifications have not been tested for sound.

### Sleek design and practical packaging

A sports exhaust system is meant to be seen. Jetex exhausts have tailpipes made of polished stainless steel. A Jetex exhaust system is uniquely designed to comprise of sections that fit into Euro size heavy duty cartons, making distribution either individually or on Euro pallets extremely efficient. This also makes stock management easy. A consumer who buys a Jetex exhaust will receive a complete exhaust kit comprising all of the necessary exhaust sections (including a mounting kit) in a carton that fits easily into the boot or backseat of their car.

### Comprehensive Guarantee

For "ALU Quality" exhausts, there is an 18 month guarantee. For "TOP Quality" and "SS Quality" exhausts the guarantee is a limited lifetime. This extended guarantee includes failure due to corrosion that passes through the metal resulting in a blow or fracture. This guarantee excludes surface discolouration or corrosion and any failure due to incorrect fitting or external impact to the exhaust system (e.g. road humps for traffic calming). For Custom Parts, Jetex do not offer any guarantee as we have no control as to how and where these parts are fitted.

A guarantee claim must include a valid (first purchaser) receipt with the date of purchase on the receipt. The guarantee is a contract between the consumer and the retailer. Therefore, any claims must firstly be directed to the retailer the exhaust was bought from.

Under the Jetex guarantee, Jetex reserve the right to replace or repair a faulty part.

## Information Disclaimer

**We reserve the right to make construction changes. The fitting information in this catalogue has been provided to the best of our knowledge and as such we cannot be held responsible for fitment changes outside of our control. Unless specifically stated, systems will not fit to turbo models, diesel models, right hand drive models, rare car body styles (such as cabriolet) or any other special variants.**





## Stainless Steel - T304



Jetex exhausts made from SS Quality steel are manufactured using predominantly 300-series stainless steel (T304). To minimize the risk of cracking, inner parts are made of chromium steel (see TOP Quality steel), which has a higher tensile strength than stainless steel. Flanges and certain mounting parts may not be made of stainless steel. Technically speaking, T304 is an austenitic stainless steel. The steel is alloyed using around 18% chromium and 8% nickel. To guarantee the best quality for welding, we only use steel with extra low carbon content. As opposed to pure chromium steel, this material is more resistant to discoloration and corrosion for a longer period of time. However, this is not true for surfaces that are welded, highly modified and/or exposed to high heat. All surfaces that are exposed to high heat will take on yellow/brown tinge or hue. This process starts at around 200°C. To keep the tail pipes from becoming yellow we use inserts to avoid discolouration of the outer surface. The outer surfaces of the silencers, in most cases, tend not to be exposed to very high heat, and can therefore be kept "clean" for several years. Products using SS Quality steel are not painted. The tailpipes are always made from polished, stainless steel.



## Stainless-Chromium Steel - T409



Jetex exhausts made from Top Quality steel are made from 400 series chromium steel (T409) From a technical point of view this material is a ferritic stainless steel. This steel is alloyed with 10-12% chromium. In order to guarantee high quality welding, the level of carbon is reduced to a very low level. Some titanium is also added to the alloy. This results in tough steel with very good welding characteristics and good resistance to surface corrosion. Over many years, this quality of stainless steel will develop a discoloured surface especially those exposed to extreme heat. Rear silencers in each kit are normally painted. The tailpipes are always made from polished stainless steel.



## Aluminised Steel



Jetex exhausts made from ALU Quality steel are made of aluminised steel. This is mild steel covered with a layer of aluminium. At Jetex, we also use material with extra thickness. This combination results in a product with a fairly long lifetime in a cost efficient way. Jetex systems made in ALU quality steel are also painted, where parts are exposed from outside the car. The tailpipes are always made from polished stainless steel. The estimated lifetime for a ALU Quality product is 3-6 years although this varies according to engine characteristics, usage and road conditions.

# Contents

Audi.....	4-12
BMW.....	13-17
Ford.....	18
Kia.....	19
Mazda.....	20-21
Saab.....	22-26
Seat.....	27-28
Skoda.....	29
Subaru.....	30
Vauxhall.....	31
Volkswagen.....	32-39
Volvo.....	40-49
Universal Exhaust Parts.....	U1-U18
Universal Exhaust Parts Technical.....	T1-T11

All Jetex Exhausts are made to conform to EU standards in terms of quality. However, to gain an EU approval, an exhaust has to be tested for sound. Those part numbers marked with the symbol below have been sound tested and have passed. They therefore carry an approval number and can be used in any country that requires an exhaust to be approved. Not all countries demand this.





80 Type 89 1.6/1.8/1.9/2.0 9/86-91  
 90 Type 89 2.0/2.3 (Not for 20V) 9/86-91  
 Coupé Type 89 2.0/2.2/2.3 (Not for 20V) 9/86+

Original 45-91R 45-2R 45-3R 45-41R

45-MH

**45-H1R<sup>EC</sup>**  
 Complete kit fits to cat/original pipework

Pipe diameter: 63,5 mm  
 Tailpipe: Round 70 mm

80/S2 Quattro 220bhp/230bhp 91-96  
 80/90 Quattro 20V 160bhp/170bhp 88-91

**45-B91R<sup>EC</sup>**  
 Back Box

Pipe diameter: 70 mm  
 Tailpipe: 2 x Round 80 mm

A3 (8L) 1.6/1.8/1.8T/1.9TDI 96-5/03

Original 41-2R 41-3R 41-4R

\*(Racepipe - T41T2R)

41-M

*Not optimised for turbo models. Use 41-H0R/TR option for turbo models. Tailpipes hang under spoiler.*

**41-HR<sup>EC</sup> /TR\***  
 Complete kit fits to catalyst  
 \*non-resonated option (no approval)

Pipe diameter: 63,5 mm  
 Tailpipe: 2 x Round 80 mm

A3 (8L) Turbo 1.8T/1.8Ti/1.9TDI 96-5/03  
 Tailpipes hang under spoiler

Original 41-20R 41-30R 41-40R

\*(Racepipe - T41T2R)

41-M0

*\*Replaces 41-20R. For tuning - extra low back pressure*

**41-H0R<sup>EC</sup> /TR\***  
 Complete kit fits to catalyst  
 \*non-resonated option (no approval)

Pipe diameter: 63,5 mm  
 Tailpipe: 2 x Round 80 mm

A3 (8P) 2WD 1.2TSi/TFSi/1.4TFSi/1.8TFSi/2.0TFSi 04+  
 Adaptor required for smaller engines. Spoiler must be trimmed for some models.

Original 40-25R 40-35R\* 40-45R 40-55R

\*(Racepipe - 40T35R)

*\*Replaces front silencer 40-35R*

40-M5

**40-H51R<sup>EC</sup> /TR\***  
 Complete kit fits to catalyst  
 \*non-resonated option (no approval)

Pipe diameter: 76 mm  
 Tailpipe: Round 100 mm

A3 (8P) 2WD 1.2TSi/TFSi/1.4TFSi/1.8TFSi/2.0TFSi 04+  
 Adaptor required for smaller engines. Spoiler must be trimmed.

Original 40-25R 40-35R 40-50R 40D45R 40-50R

\*(Racepipe - 40T35R)

*\*Replaces front silencer 40-35R*

40DM5

**40DH51R<sup>EC</sup> /TR\***  
 Complete kit fits to catalyst  
 \*non-resonated option (no approval)

Pipe diameter: 76 mm  
 Tailpipe: Duplex Round 100 mm

<p><b>A3 (8P) 2WD 1.2TFSi/TFSi/1.4TFSi/1.8TFSi/2.0TFSi</b> 04+</p> <p><i>Adaptor required for smaller engines. Spoiler must be trimmed.</i></p> <p><i>*(Racepipe - 40T35R)</i> <i>*Replaces front silencer 40-35R</i></p>	<p><b>40DH5DR<sup>EC</sup> /TR*</b></p> <p>Complete kit fits to catalyst <i>*non-resonated option (no approval)</i></p> <p>Pipe diameter: 76 mm Tailpipe: Quad Round 80 mm</p>
---	--

<p><b>A3 (8P) 2WD 1.2TFSi/TFSi/1.4TFSi/1.8TFSi/2.0TFSi</b> 04+</p> <p><i>Adaptor required for smaller engines. Spoiler must be trimmed.</i></p>	<p><b>40DB5DR<sup>EC</sup></b></p> <p>Back box</p> <p>Pipe diameter: 76 mm + 2x63,5 mm Tailpipe: Quad Round 80 mm</p>
---	---

<p><b>A3 (8P) 2WD 1.2TFSi/TFSi/1.4TFSi/1.8TFSi/2.0TFSi</b> 04+</p> <p><i>Adaptor required for smaller engines. Spoiler must be trimmed.</i></p> <p><i>*(Racepipe - 40T35R)</i> <i>*Replaces front silencer 40-35R</i></p>	<p><b>40-H5DR<sup>EC</sup> /TR*</b></p> <p>Complete kit fits to catalyst <i>*non-resonated option (no approval)</i></p> <p>Pipe diameter: 76 mm Tailpipe: 2 x Round 80 mm</p>
---	---

<p><b>A3 (8P) 2WD 1.2TFSi/TFSi/1.4TFSi/1.8TFSi/2.0TFSi</b> 04+</p> <p><i>Adaptor required for smaller engines. Spoiler must be trimmed.</i></p>	<p><b>40-B5DR<sup>EC</sup></b></p> <p>Back box</p> <p>Pipe diameter: 76 mm Tailpipe: 2 x Round 80 mm</p>
---	--

<p><b>A3 (8PA) 2WD Sportback 1.8TFSi/2.0TFSi</b> 04+</p> <p><i>*(Racepipe - 40T35R)</i> <i>*Replaces front silencer 40-35R</i></p>	<p><b>40-H3DR<sup>EC</sup> /TR*</b></p> <p>Complete kit fits to catalyst <i>*non-resonated option (no approval)</i></p> <p>Pipe diameter: 76 mm Tailpipe: 2 x Round 80 mm</p>
--	---

<p><b>A3 (8PA) 2WD Sportback 1.8TFSi/2.0TFSi</b> 04+</p> <p><i>The spoiler must be trimmed.</i></p> <p><i>*(Racepipe - 40T35R)</i> <i>*Replaces front silencer 40-35R</i></p>	<p><b>40DH3DR<sup>EC</sup> /TR*</b></p> <p>Complete kit fits to catalyst <i>*non-resonated option (no approval)</i></p> <p>Pipe diameter: 76 mm Tailpipe: Quad Round 80 mm</p>
---	--



<p>A3 (8P/8PA) Quattro and Sportback 2.0TFSi 200bhp 05+</p>	<p><b>40T20R200/40-1B</b></p> <p>Downpipe (with or without cat)</p> <p>These parts fit to Jetex mid-silencer 40-2B or racepipe 40-2C and back silencer 40-BAR/BBR or BCR.</p> <p><i>Pipe diameter: 76 mm. For track/off-road use.</i></p>
---	---

<p>A3 (8P/8PA) Quattro and Sportback 2.0TFSi 200bhp 05+</p>	<p><b>40-2B/40-2C</b></p> <p>Mid-silencer/racepipe</p> <p>These parts fit to Jetex downpipe 40-1B or 40T20R2000 and back silencer 40-BAR/BBR or BCR.</p> <p><i>Pipe diameter: 76 mm</i></p>
---	---

<p>A3 (8PA) Quattro Sportback 2.0TFSi 05+</p> <p>40-BAR can be fitted to the OE exhaust on its own as a back box or with downpipe/centre sections shown above.</p>	<p><b>40-BAR</b></p> <p>Back Boxes Fits to original pipework</p> <p><i>Pipe diameter: 76 mm Tailpipe: 2 x Round 80 mm</i></p>
--	---

<p>A3 (8P) Quattro 2.0TFSi 200bhp 05+</p> <p>40-BBR can be fitted to the OE exhaust on its own as a back box or with downpipe/centre sections shown above.</p>	<p><b>40-BBR</b></p> <p>Back Boxes Fits to original pipework</p> <p><i>Pipe diameter: 76 mm Tailpipe: 2 x Round 80 mm</i></p>
--	---

<p>A4 (B5) Quattro Saloon/Estate 1.8/1.8T 150/180bhp 94-00 A4 (B5) Quattro Saloon/Estate 1.9 TDI 90/110/115bhp 94-00</p> <p><i>*(Racepipe - 42T38R)</i></p> <p><i>*Replaces front silencer 42-38R</i></p>	<p><b>42-H8R<sup>EC</sup> /TR<sup>*</sup></b></p> <p>Complete kit fits to cat/flexible part <i>*non-resonated option (no approval)</i></p> <p><i>Pipe diameter: 63,5 mm Tailpipe: 2 x Round 80 mm</i></p>
---	---

<p>A4 (B5) Quattro Saloon/Estate 2.4/2.6/2.8 94-00 A4 (B5) Quattro Saloon/Estate 2.5TDI 94-00</p> <p><i>*(Racepipe - 42T38R)</i></p> <p><i>*Replaces front silencer 42-38R</i></p>	<p><b>42-H9R<sup>EC</sup> /TR<sup>*</sup></b></p> <p>Complete kit fits to cat/flexible part <i>*non-resonated option (no approval)</i></p> <p><i>Pipe diameter: 63,5 mm Tailpipe: 2 x Round 80 mm</i></p>
--	---

<p>A4 (B6) 2WD Saloon/Estate 1.6i/2.0i/1.9TDi -05</p> <p>Original</p> <p>44-61R</p> <p>44-72R</p> <p>44-82R</p> <p>44DM0B</p> <p>The spoiler must be trimmed.</p>	<p><b>44DB0R<sup>EC</sup></b></p> <p>Back boxes</p> <p>Pipe diameter: 63,5 mm + 2x50,8 mm Tailpipe: Duplex Round 100 mm</p>
---	---

<p>A4 (B6) 2WD Saloon/Estate 1.8T 01-04 A4 (B6) 2WD Cabriolet 1.8T 01-09</p> <p>Original</p> <p>044-82R</p> <p>44-62R</p> <p>44-52R</p> <p>44-72R</p> <p>44-M2B</p>	<p><b>44DB2R<sup>EC</sup></b></p> <p>Back boxes</p> <p>Pipe diameter: 2x50,8 mm Tailpipe: Duplex Round 100 mm</p>
---	---

<p>A4 (B6) 2WD Saloon/Estate 1.8T 01-04 A4 (B6) 2WD Cabriolet 1.8T 01-09</p> <p>Original</p> <p>44-32R</p> <p>44-42R</p> <p>44-82R</p> <p>44-62R</p> <p>44-52R</p> <p>44-72R</p> <p>*(Racepipe - 44T42R)</p> <p>44-M2</p> <p>*Replaces front silencer 44-42R</p>	<p><b>44DH2R<sup>EC</sup> /TR*</b></p> <p>Complete kit fits to cat/flexible part *non-resonated option (no approval)</p> <p>Pipe diameter: 63,5 mm + 2x50,8 mm Tailpipe: Duplex Round 100 mm</p>
--	--

<p>A4 (B6) Quattro Saloon/Estate 1.8T 01-04 A4 (B6) Quattro Cabriolet 1.8T 01-09</p> <p>Original</p> <p>44-82R</p> <p>44-64R</p> <p>44-54R</p> <p>44-72R</p> <p>44-M2B</p>	<p><b>44DB4R<sup>EC</sup></b></p> <p>Back boxes</p> <p>Pipe diameter: 2x50,8 mm Tailpipe: Duplex Round 100 mm</p>
--	---

<p>A4 (B6) Quattro Saloon/Estate 1.8T 01-04 A4 (B6) Quattro Cabriolet 1.8T 01-09</p> <p>Original</p> <p>44-34R</p> <p>44-44R</p> <p>44-64R</p> <p>44-82R</p> <p>44-54R</p> <p>44-72R</p> <p>*(Racepipe - 44T44R)</p> <p>44-M2</p> <p>*Replaces front silencer 44-44R</p>	<p><b>44DH4R<sup>EC</sup> /TR*</b></p> <p>Complete kit fits to cat/flexible part *non-resonated option (no approval)</p> <p>Pipe diameter: 63,5 mm + 2x50,8 mm Tailpipe: Duplex Round 100 mm</p>
--	--

<p>A4 (B7) 2WD Saloon/Estate 1.6i/2.0i/1.9TDi/2.0TDi 05+</p> <p>Original</p> <p>44-61R</p> <p>44-73R</p> <p>44-83R</p> <p>44DM0B</p>	<p><b>44DB1R<sup>EC</sup></b></p> <p>Back boxes</p> <p>Pipe diameter: 2x50,8 mm Tailpipe: Duplex Round 100 mm</p>
--	---



**A4 (B7) 2WD Saloon/Estate 1.8T/2.0TFSi 05+**

Original 44-83R  
44-62R  
44-52R  
44-73R

44-M2B

**44DB3R<sup>EC</sup>**  
Back boxes

Pipe diameter: 2x50,8 mm  
Tailpipe: Duplex Round 100 mm

**A4 (B7) 2WD Saloon/Estate 1.8T/2.0TFSi 05+**

Original 44-32R 44-42R 44-83R  
44-62R  
44-52R 44-73R

\*(Racepipe - 44T42R)

44-M2

*\*Replaces front silencer 44-42R*

**44DH3R<sup>EC</sup> /TR\***  
Complete kit fits to cat/flexible part

\*non-resonated option (no approval)

Pipe diameter: 63,5 mm + 2x50,8 mm  
Tailpipe: Duplex Round 100 mm

**A4 (B7) Quattro Saloon/Estate 1.8T/2.0TFSi 05+**

Original 44-83R  
44-64R  
44-54R  
44-73R

44-M2B

**44DB5R<sup>EC</sup>**  
Back boxes

Pipe diameter: 2x50,8 mm  
Tailpipe: Duplex Round 100 mm

**A4 (B7) Quattro Saloon/Estate 1.8T/2.0TFSi 05+**

Original 44-34R 44-44R 44-83R  
44-64R  
44-54R 44-73R

\*(Racepipe - 44T44R)

44-M2

*\*Replaces front silencer 44-44R*

**44DH5R<sup>EC</sup> /TR\***  
Complete kit fits to cat/flexible part

\*non-resonated option (no approval)

Pipe diameter: 63,5 mm + 2x50,8 mm  
Tailpipe: Duplex Round 100 mm

**A4 (B8) 1.8T/2.0T Saloon/Avant/All Road 2WD/Quattro 08+  
A5 1.8T/2.0T Coupe/Sportback 2WD/Quattro 06+**

Original 48-941R 48-34R 48-44R  
48-942R 48-54DR

\*(Racepipe - 48T34R)

48-M4R

*\*Replaces front silencer 48-34R. To be used for models with exhaust exit on left side.*

**48-H4DR/TR\***  
Fits after original downpipe/silencer.

\*non-resonated option (no approval)

Pipe diameter: 70 mm  
Tailpipe: 2 x Round 80 mm

**A4 (B8) 1.8T/2.0T Saloon/Avant/All Road 2WD/Quattro 08+  
A5 1.8T/2.0T Coupe/Sportback 2WD/Quattro 06+**

Original 48-941R 48-34R 48D44R 48D64DR  
48-942R 48D54DR

\*(Racepipe - 48T34R)

48DM4R

*\*Replaces front silencer 48-34R. The diffuser must be trimmed for right tailpipe or replaced. An original diffuser from an SS can be used on vehicles with S-Line exterior kit.*

**48DH4DR<sup>EC</sup> /TR\***  
Fits after original downpipe/silencer.

\*non-resonated option (no approval)

Pipe diameter: 70 mm + 2x57 mm  
Tailpipe: Quad Round 80 mm

A4 (B8) 1.8T/2.0T Saloon/Avant/All Road 2WD/Quattro  
A5 1.8T/2.0T Coupe/Sportback 2WD/Quattro

08+  
06+

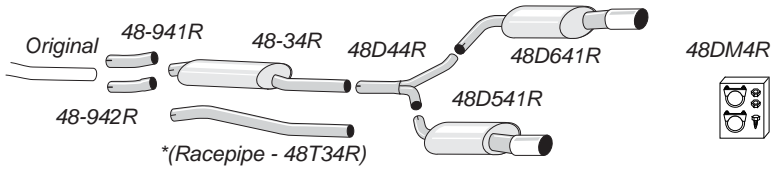

\*Replaces front silencer 48-34R. To be used for models with a cutout for a single tailpipe left and right side, or use original diffuser from 6-cyl engines.

## 48DH41R<sup>EC</sup> /TR\*

Fits after original downpipe/silencer.

\*non-resonated option (no approval)



Pipe diameter: 70 mm + 2x57 mm  
Tailpipe: Duplex Round 100 mm

A4 (B8) 2.0TDi Saloon/Avant/All Road 2WD/Quattro  
A5 2.0TDi Coupe/Sportback 2WD/Quattro

08+  
06+

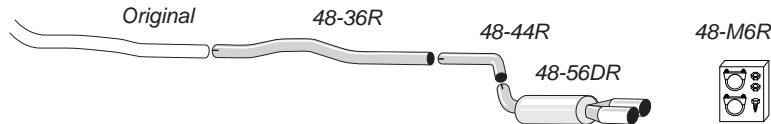

To be used for models with exhaust exit on left side.

## 48-H6DR

Fits after original downpipe with parts.



Pipe diameter: 70 mm  
Tailpipe: 2 x Round 80 mm

A4 (B8) 2.0TDi Saloon/Avant/All Road 2WD/Quattro  
A5 2.0TDi Coupe/Sportback 2WD/Quattro

08+  
06+

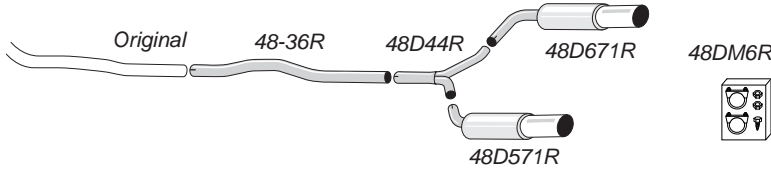

To be used with original diffuser from 6-cyl engines. Not for models with AdBlue tank.

## 48DH61R<sup>EC</sup>

Fits after original downpipe with parts



Pipe diameter: 70 mm + 2x57 mm  
Tailpipe: Duplex Round 100 mm

A4 (B8) 2.0TDi Saloon/Avant/All Road 2WD/Quattro  
A5 2.0TDi Coupe/Sportback 2WD/Quattro

08+  
06+

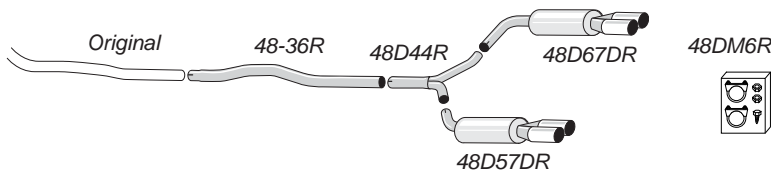

To be used with original diffuser from 6-cyl engines. Not for models with AdBlue tank.

## 48DH6DR<sup>EC</sup>

Fits after original downpipe with parts



Pipe diameter: 70 mm + 2x57 mm  
Tailpipe: Quad Round 80 mm

A4 (B8) 2.7/3.0TDi Saloon/Avant/Allroad 2WD/Quattro  
A5 2.7TDi/3.0TDi Coupe/Sportback 2WD/Quattro

08+  
06+

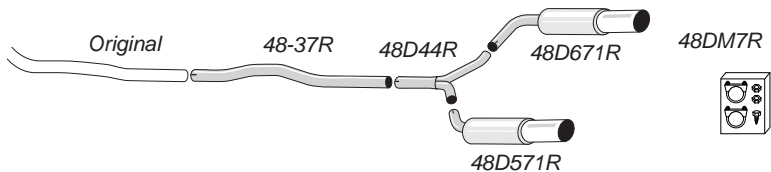

Not for models with AdBlue tank.

## 48DH71R<sup>EC</sup>

Fits after original downpipe with parts



Pipe diameter: 70 mm + 2x57 mm  
Tailpipe: Duplex Round 100 mm

A4 (B8) 2.7/3.0TDi Saloon/Avant/Allroad 2WD/Quattro  
A5 2.7TDi/3.0TDi Coupe/Sportback 2WD/Quattro

08+  
06+

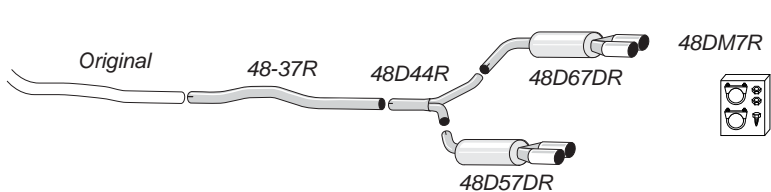

Not for models with AdBlue tank.

## 48DH7DR<sup>EC</sup>

Fits after original downpipe with parts



Pipe diameter: 70 mm + 2x57 mm  
Tailpipe: Quad Round 80 mm



A8 2WD/Quattro 2.5TDI/2.8/3.7/4.2L 94-02

**AA-BDR**  
Back Box  
Fits to original pipework

Pipe diameter: 57 mm  
Tailpipe: 2 x Round 80 mm

RS2 (B4) 2.2i Quattro Saloon/Estate  
S2 (B4) 2.2i Quattro Saloon/Estate

**43-H5DR**  
Complete kit fits to cats/original pipework

Pipe diameter: 76 mm  
Tailpipe: 2 x Round 80 mm

RS4 Quattro Saloon/Estate 2.7 380bhp 00-02

\* Replaces front silencer 42-395R.

**42-H95R<sup>EC</sup>/TR<sup>\*</sup>**  
Complete kit fits to catalyst  
<sup>\*</sup>non-resonated option (no approval)

Pipe diameter: 76 mm  
Tailpipe: 2 x Oval 90/120 mm

S3 (8L) Quattro 1.8i Turbo 210/225bhp 99-5/03

\*Replaces front silencer 41-38R.  
Can be used also for A3 Quattro if the spoiler is trimmed or replaced by a spoiler from an S3.

**41-HAR<sup>EC</sup>/TR<sup>\*</sup>**  
Complete kit fits to catalyst  
<sup>\*</sup>non-resonated option (no approval)

Pipe diameter: 70 mm  
Tailpipe: Oval 85/150 mm

S3 (8P/8PA) Quattro + Sportback 2.0TFSi 265bhp 07+

**40T20R200/40-1B**  
Downpipe (with or without cat)

These parts fit to Jetex mid-silencer 40-2B or racepipe 40-2C and back silencer 40-BAR/BBR or BCR.

Pipe diameter: 76 mm. For track/off-road use.

S3 (8P/8PA) Quattro + Sportback 2.0TFSi 265bhp 07+

**40-2B/40-2C**  
Mid-silencer/racepipe

These parts fit to Jetex downpipe 40-1B or 40T20R2000 and back silencer 40-BAR/BBR or BCR.

Pipe diameter: 76 mm

**S3 (8P) Quattro 2.0TFSi 265bhp 07+**

Original      40-4AR      40-5BR

40-BBR can be fitted to the OE exhaust on its own as a back box or with downpipe/centre sections shown above.

**40-BBR**  
Back Box  
Fits to original pipework

Pipe diameter: 76 mm  
Tailpipe: 2 x Round 80 mm

**S3 (8P) Quattro Sportback 2.0TFSi 265bhp 07+**

Original      40-4AR      40-5CR

40-BCR can be fitted to the OE exhaust on its own as a back box or with downpipe/centre sections shown on previous page.

**40-BCR**  
Back Box  
Fits to original pipework

Pipe diameter: 76 mm  
Tailpipe: 2 x Round 80 mm

**S3 (8V) Sportback 2.0TFSI 2013-18**

4B-95R    4B-35R    \*4BT35R    4BD54DR    4BD75DR    4BDM5    4BD45R    4BD65DR

\* Replaces front silencer 4B-35R

**4BDH4DR/TR\***

Complete kit fits to OE downpipe  
\*non-resonated option

Pipe diameter: 76 mm + 2x63,5 mm  
Tailpipe: Duplex Quad Round 90 mm

**S4 Quattro Saloon/Estate 2.7 265bhp 98-01**

Original    42-294R    42-395R    \*42T395R    42-494R

\* Replaces front silencer 42-395R.

**42-H94R<sup>EC</sup>/TR\***

Complete kit fits to catalyst  
\*non-resonated option (no approval)

Pipe diameter: 76 mm  
Tailpipe: 2 x Round 80 mm

**S8 2WD/Quattro 2.5TDI/2.8/3.7/4.2L 94-02**

**AA-BDR**  
Back Box  
Fits to original pipework

Pipe diameter: 57 mm  
Tailpipe: 2 x Round 80 mm

**TT (8N) 2WD Coupé/Roadster 1.8T 180bhp 98-6/06**

Original    41-29R    41-3R    41-49R

**41-H9R**  
Complete kit fits to catalyst

Pipe diameter: 63,5 mm  
Tailpipe: Round 100 mm



TT (8N) Quattro Coupé/Roadster 1.8T 180/225bhp

98-6/06

## 41-H8R<sup>EC</sup>/TR\*

Complete kit fits to catalyst

\*non-resonated option (no approval)

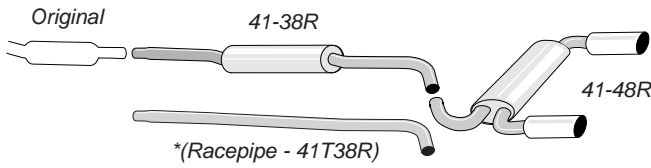

\* Replaces front silencer 41-38R.



Pipe diameter: 70 mm

Tailpipe: Duplex Round 100 mm

E30 320i/323i/325i 6cyl 10/82-9/87  
(Not UK, Sweden or Switzerland)

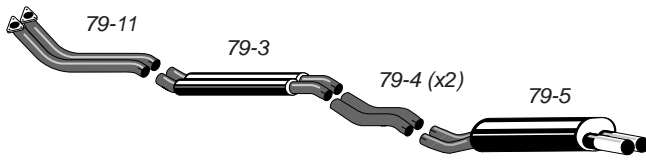

Fits to models with twin 2 x triangular 3 bolt flanges on manifold

## 79-K2<sup>EC</sup>

Complete kit fits to manifold



Pipe diameter: 45 mm  
Tailpipes: 2 x Round 70 mm

ALU Quality



E36 Z3 1.9 16V

94+

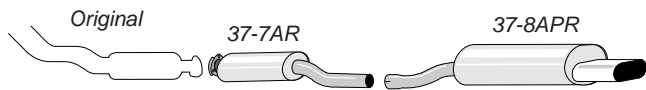

## 37-HAPR<sup>EC</sup>

Complete kit fits to catalyst



Pipe diameter: 63,5 mm  
Tailpipe: Oval 70/140 mm



E46 316i/318i  
Saloon/Coupé/Touring

98-05

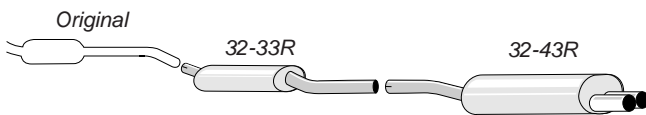

## 32-H3R

Complete kit fits to catalyst



Pipe diameter: 63,5 mm  
Tailpipe: 2 x Round 70 mm



E46 316i/318i  
Saloon/Coupé/Touring

98-05

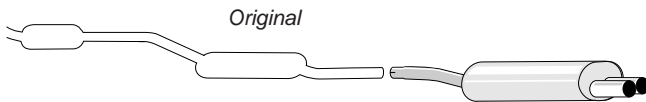

## 32-B3R

Back Box



Pipe diameter: 63,5 mm  
Tailpipe: 2 x Round 70 mm



E46 320i Saloon/Touring/Coupé M52/2.0L 97-01  
E46 323i Saloon/Touring/Coupé M52/2.5L 97-00  
E46 328i Saloon/Touring/Coupé M52/2.8L 97-00

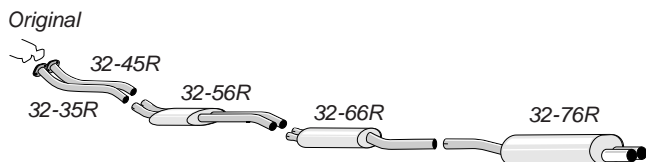

## 32-H5R<sup>EC</sup>

Complete kit fits to catalyst



Pipe diameter: 2x51 mm + 70 mm  
Tailpipe: 2 x Round 70 mm



E46 320i Saloon/Touring/Coupé/Cabrio M54/2.2L 99+  
E46 325i Saloon/Touring/Coupé/Cabrio M54/2.5L 00+  
E46 330i Saloon/Touring/Coupé/Cabrio M54/3.0L 9/00+

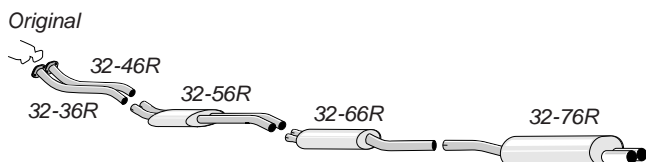

## 32-H6R<sup>EC</sup>

Complete kit fits to catalyst



Pipe diameter: 2x51 mm + 70 mm  
Tailpipe: 2 x Round 70 mm





E60 520i/523i/525i/530i Saloon 03+  
E60 520D/525D/530D/535D\*\* Saloon 03+

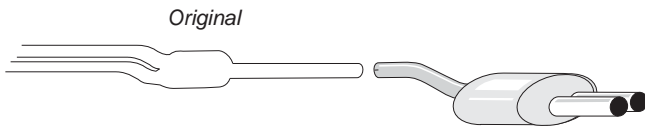

\*\*use adaptor 39-960R to fit to these models

## 39-B5DR

Back Box



Pipe diameter: 76 mm  
Tailpipe: 2 x Round 80 mm



E82 1M Coupe 340bhp 11+

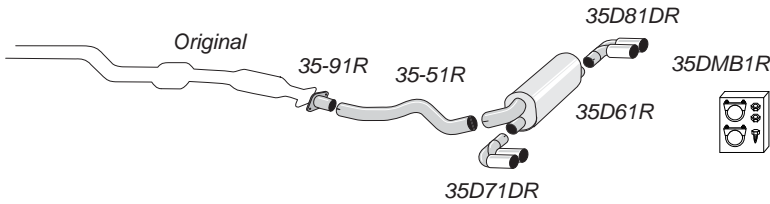

## 35DB1DR

Back box fits to cat/original parts



Pipe diameter: 89 mm + 2x63,5 mm  
Tailpipe: Quad Round 90 mm



E90 316D/318D/320D Saloon/Touring/Coupe/Cabrio 05-12

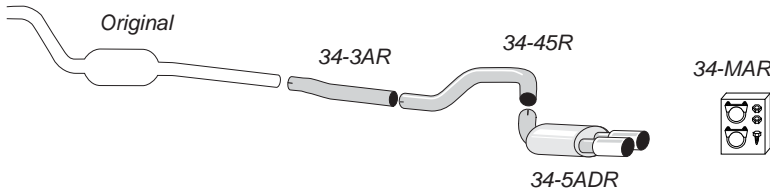

## 34-HADR

Complete kit fits original front pipe



Pipe diameter: 70 mm  
Tailpipe: 2 x Round 80 mm (adjustable)



F30 316D/318D/320D Saloon 2011-6/15  
F31 316D/318D/320D Touring 2012-6/15  
(including xDrive) (Not meant for vehicles with Blue Performance/Euro 6 as 3A-31R replaces NOx cat)

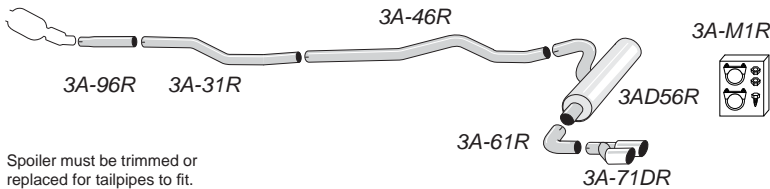

Spoiler must be trimmed or replaced for tailpipes to fit.

## 3A-H6DR

Complete kit fits to cat/flexi-pipe



Pipe diameter: 76 mm + 63,5 mm  
Tailpipe: 2 x Round 80 mm



F30 316D/318D/320D Saloon 2011-6/15  
F31 316D/318D/320D Touring 2012-6/15  
(including xDrive) (Not meant for vehicles with Blue Performance/Euro 6 as 3A-31R replaces NOx cat)

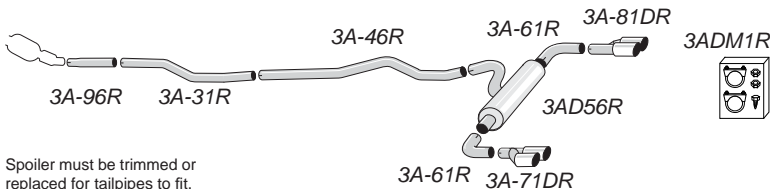

Spoiler must be trimmed or replaced for tailpipes to fit.

## 3ADH6DR

Complete kit fits to cat/flexi-pipe



Pipe diameter: 76 mm + 63,5 mm  
Tailpipe: Quad Round 80 mm



F30 316D/318D/320D Saloon 2011-6/15  
F31 316D/318D/320D Touring 2012-6/15  
(including xDrive) (Not meant for vehicles with Blue Performance/Euro 6 as 3A-31R replaces NOx cat)

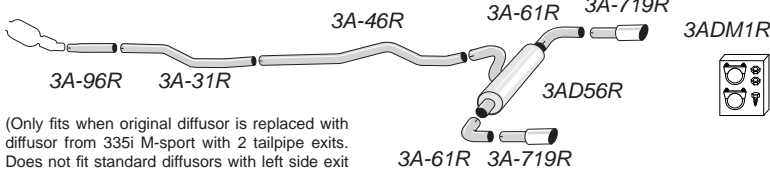

(Only fits when original diffuser is replaced with diffuser from 335i M-sport with 2 tailpipe exits. Does not fit standard diffusers with left side exit due to tailpipe location)

## 3ADH69R

Complete kit fits to cat/flexi-pipe



Pipe diameter: 76 mm + 63,5 mm  
Tailpipe: Duplex Round 90 mm



**F34 318D/320D GT** 2013-5/16  
(including xDrive) (Not meant for vehicles with Blue Performance/Euro 6 as 3B-31R replaces NOx cat)

3A-96R 3B-31R 3A-46R 3B-61R 3A-M1R 3AD56R 3A-71DR

Spoiler must be trimmed or replaced for tailpipes to fit.

**3B-H6DR**  
Complete kit fits to cat/flexi-pipe

Pipe diameter: 76 mm + 63,5 mm  
Tailpipe: 2 x Round 80 mm

**F34 318D/320D GT** 2013-5/16  
(including xDrive) (Not meant for vehicles with Blue Performance/Euro 6 as 3B-31R replaces NOx cat)

3A-96R 3B-31R 3A-46R 3B-61R 3A-81DR 3ADM1R 3AD56R 3B-61R 3A-71DR

Spoiler must be trimmed or replaced for tailpipes to fit.

**3BDH6DR**  
Complete kit fits to cat/flexi-pipe

Pipe diameter: 76 mm + 63,5 mm  
Tailpipe: Quad Round 80 mm

**F34 318D/320D GT** 2013-5/16  
(including xDrive) (Not meant for vehicles with Blue Performance/Euro 6 as 3B-31R replaces NOx cat)

3A-96R 3B-31R 3A-46R 3B-61R 3A-719R 3ADM1R 3AD56R 3B-61R 3A-719R

(Only fits when original diffuser is replaced with diffuser from 335i M-sport with 2 tailpipe exits. Does not fit standard diffusers with left side exit due to tailpipe location)

**3BDH69R**  
Complete kit fits to cat/flexi-pipe

Pipe diameter: 76 mm + 63,5 mm  
Tailpipe: Duplex Round 90 mm

**F30 320i/328i Saloon** 2011-6/15  
**F31 320i/328i Estate** 2012-6/15  
(including xDrive)

3A-91R 3A-31R 3A-41R 3AD51R 3A-M1R 3A-61R 3A-71DR

Spoiler must be trimmed or replaced for tailpipes to fit.

**3A-H1DR**  
Complete kit fits to catalyst

Pipe diameter: 76 mm + 63,5 mm  
Tailpipe: 2 x Round 80 mm

**F30 320i/328i Saloon** 2011-6/15  
**F31 320i/328i Estate** 2012-6/15  
(including xDrive)

3A-91R 3A-31R 3A-41R 3A-61R 3A-81DR 3ADM1R 3AD51R 3A-61R 3A-71DR

Spoiler must be trimmed or replaced for tailpipes to fit.

**3ADH1DR**  
Complete kit fits to catalyst

Pipe diameter: 76 mm + 63,5 mm  
Tailpipe: Quad Round 80 mm

**F30 320i/328i Saloon** 2011-6/15  
**F31 320i/328i Estate** 2012-6/15  
(including xDrive)

3A-91R 3A-31R 3A-41R 3A-61R 3A-719R 3ADM1R 3AD51R 3A-61R 3A-719R

(Only fits when original diffuser is replaced with diffuser from 335i M-sport with 2 tailpipe exits. Does not fit standard diffusers with left side exit due to tailpipe location)

**3ADH19R**  
Complete kit fits to catalyst

Pipe diameter: 76 mm + 63,5 mm  
Tailpipe: 2 x Round 90 mm

**F34 320i 2.0T 135kW/181bhp GT** 2013-5/16  
(including xDrive)

3A-91R 3B-31R 3A-41R 3AD51R 3A-M1R 3B-61R 3A-71DR

Spoiler must be trimmed or replaced for tailpipes to fit.

**3B-H1DR**  
Complete kit fits to catalyst

Pipe diameter: 76 mm + 63,5 mm  
Tailpipe: 2 x Round 80 mm

**F34 320i 2.0T 135kW/181bhp GT** 2013-5/16  
(including xDrive)

3A-91R 3B-31R 3A-41R 3B-61R 3A-81DR 3AD51R 3ADM1R 3B-61R 3A-71DR

Spoiler must be trimmed or replaced for tailpipes to fit.

**3BDH1DR**  
Complete kit fits to catalyst

Pipe diameter: 76 mm + 63,5 mm  
Tailpipe: Quad Round 80 mm

**F34 320i 2.0T 135kW/181bhp GT** 2013-5/16  
(including xDrive)

3A-91R 3B-31R 3A-41R 3B-61R 3A-719R 3AD51R 3ADM1R 3B-61R 3A-719R

(Only fits when original diffuser is replaced with diffuser from 335i M-sport with 2 tailpipe exits. Does not fit standard diffusers with left side exit due to tailpipe location)

**3BDH19R**  
Complete kit fits to catalyst

Pipe diameter: 76 mm + 63,5 mm  
Tailpipe: 2 x Round 90 mm

**F32/F33/F36 420D Cabriolet/Coupe/Gran Coupe** 2013-6/15  
(including xDrive) (Not meant for vehicles with Blue Performance/Euro 6 as 3A-31R replaces NOx cat)

3A-96R 3A-31R 3A-46R 3A-61R 3AD56R 3A-M1R 3A-71DR

Spoiler must be trimmed or replaced for tailpipes to fit.

**3A-H6DR**  
Complete kit fits to cat/flexi-pipe

Pipe diameter: 76 mm + 63,5 mm  
Tailpipe: 2 x Round 80 mm

**F32/F33/F36 420D Cabriolet/Coupe/Gran Coupe** 2013-6/15  
(including xDrive) (Not meant for vehicles with Blue Performance/Euro 6 as 3A-31R replaces NOx cat)

3A-96R 3A-31R 3A-46R 3A-61R 3A-81DR 3AD56R 3ADM1R 3A-61R 3A-71DR

Spoiler must be trimmed or replaced for tailpipes to fit.

**3ADH6DR**  
Complete kit fits to cat/flexi-pipe

Pipe diameter: 76 mm + 63,5 mm  
Tailpipe: Quad Round 80 mm

**F32/F33/F36 420D Cabriolet/Coupe/Gran Coupe** 2013-6/15  
(including xDrive) (Not meant for vehicles with Blue Performance/Euro 6 as 3A-31R replaces NOx cat)

3A-96R 3A-31R 3A-46R 3A-61R 3A-719R 3AD56R 3ADM1R 3A-61R 3A-719R

(Only fits when original diffuser is replaced with diffuser from 335i M-sport with 2 tailpipe exits. Does not fit standard diffusers with left side exit due to tailpipe location)

**3ADH69R**  
Complete kit fits to cat/flexi-pipe

Pipe diameter: 76 mm + 63,5 mm  
Tailpipe: Duplex Round 90 mm



F32/F33/F36 420i/428i 2013-6/15  
Cabriolet/Coupe/Gran Coupe (including xDrive)

Spoiler must be trimmed or replaced for tailpipes to fit.

## 3A-H1DR

Complete kit fits to catalyst

Pipe diameter: 76 mm + 63,5 mm  
Tailpipe: 2 x Round 80 mm

F32/F33/F36 420i/428i 2013-6/15  
Cabriolet/Coupe/Gran Coupe (including xDrive)

(Only fits when original diffuser is replaced with diffuser from 335i M-sport with 2 tailpipe exits. Does not fit standard diffusers with left side exit due to tailpipe location)

## 3ADH19R

Complete kit fits to catalyst

Pipe diameter: 76 mm + 63,5 mm  
Tailpipe: 2 x Round 90 mm

F32/F33/F36 420i/428i 2013-6/15  
Cabriolet/Coupe/Gran Coupe (including xDrive)

Spoiler must be trimmed or replaced for tailpipes to fit.

## 3ADH1DR

Complete kit fits to catalyst

Pipe diameter: 76 mm + 63,5 mm  
Tailpipe: Quad 4 x Round 80 mm



Focus RS I 2.0L 158kW/215bhp 03+

Original

51-27R

51-37R

51-47R

51-M8R

**51-H7R**

Complete kit fits to catalyst

Pipe diameter: 70 mm  
Tailpipe: Round 100 mm

Focus RS II 2.5L 224kW/305bhp 09+

Original

T19-9AR

T19-3AR

T19-4AR

T19-5SR

T19-6SR

T19-7SR

T19-MAR

**T19-HSR**

Complete kit fits to catalyst

Pipe diameter: 76,5 mm  
Tailpipe: Duplex Round 114 mm

Focus ST 2.5L 168kW/225bhp 06+

Original

19-9AR

19-3AR

19-4AR

19-5AR

19-6FR

19-7FR

(Racepipe - 19T3AR\*)

\* Replaces front silencer 19-3AR

**19-HFR<sup>EC</sup> /TR<sup>\*</sup>**

Complete kit fits to catalyst

\*non-resonated option (no approval)

Pipe diameter: 63,5 mm  
Tailpipe: Duplex Round 100 mm

ProCeed GT 1.6 204bhp 2013-18



## K2DHzR

Complete kit fits to catalyst



Pipe diameter: 76,5 mm

Tailpipe: Duplex Oval 90/120 mm





**3 MPS | 2.3L Turbo 06-09**

Original 51-28R 51-38R 51-48R 51-M8R

51-19R

Cat-replacement pipe 51-19R is available (for 2nd catalyst).

**51-H8R**

Complete kit fits to catalyst

Pipe diameter: 70 mm  
Tailpipe: Round 114 mm

**6 MPS 2.3L Turbo 05+**

Original 18-3AR 18D4AR 18D6AR 18DMAR

18-2AR

18D5AR

Cat-replacement pipe 18-2AR is available (for 2nd catalyst).

**18DHAR**

Complete kit fits to catalyst

Pipe diameter: 76 mm  
Tailpipe: Duplex Oval 90/120 mm

**MX-5 Coupé/Cabrio type NA 1.6i 16V/1.8i 16V 90-96**  
(for 1.6L fits up to chassis 100206, catalyst length 370/440mm)  
(for 1.8L fits up to chassis 308212, catalyst length 370/440mm)

Original 14-30R 14-40R 14-50R 14-M0

**14-H0R**

Complete kit fits to catalyst

Pipe diameter: 63,5 mm  
Tailpipe: Round 100 mm

**MX-5 Coupé/Cabrio type NA 1.6i 16V/1.8i 16V 1996-98**  
(for 1.6L fits to chassis 100207 onwards, catalyst length 475mm)  
(for 1.8L fits to chassis 308213 onwards, catalyst length 475mm)

Original 14-31R 14-40R 14-50R 14-M0

**14-H1R**

Complete kit fits to catalyst

Pipe diameter: 63,5 mm  
Tailpipe: Round 100 mm

**MX-5 Coupé/Cabrio type NA 1.6i 16V/1.8i 16V 90-96**  
(for 1.6L fits up to chassis 100206, catalyst length 370/440mm)  
(for 1.8L fits up to chassis 308212, catalyst length 370/440mm)

Original 14-30R 14-40R 14-52R 14-M0

Spoiler must be trimmed for the left side tailpipe.

**14-H2R**

Complete kit fits to catalyst

Pipe diameter: 63,5 mm  
Tailpipe: Duplex Round 100 mm

**MX-5 (Miata) type NB 1.6/1.8 98-05**

Original

**14-B5R**

Back Box

Pipe diameter: 63,5 mm  
Tailpipe: Round 100 mm

MX-5 (Miata) type NB 1.6/1.8 98-05

Original

Spoiler must be trimmed for the left side tailpipe.

**14DB5R**

Back Box

Pipe diameter: 63,5 mm  
Tailpipe: Duplex Round 100 mm

MX-5 (Miata) type NB 1.6/1.8 98-05

Use 14-26R when OE flange is before catalyst.

Use 14-25R when OE flange is after catalyst.

**14-H5R**

Complete kit fits to catalyst

Pipe diameter: 63,5 mm  
Tailpipe: Round 100 mm

MX-5 (Miata) typ NB 1.6/1.8 98-05

Use 14-26R when OE flange is before catalyst.

Use 14-25R when OE flange is after catalyst.

Spoiler must be trimmed for the left side tailpipe.

**14DH5R**

Complete kit fits to catalyst

Pipe diameter: 63,5 mm  
Tailpipe: Duplex Round 100 mm

MX-5 (Miata) type NC 06+

Original

**14DB89R**

Back box

Tailpipe: Duplex Round 90 mm



SAAB 93/96 2 Stroke 1956+

07-1 07-2 07-2B 07-3 07-40

07-M

**07-K0**  
Complete kit

ALU Quality

Pipe diameter: 50,8 mm

96 V4 Saloon 66-79

44-1 44-2 44-3 44-4 44-5 44-6

44-M

**44-K**  
Complete kit

ALU Quality

Pipe diameter: 50,8 mm  
Tailpipe: Round 70 mm

99 Single Flange -1975

65-1 65-20 65-30 65-40

65-M

**65-K**  
Complete kit

ALU Quality

Pipe diameter: 50,8 mm  
Tailpipe: Round 50,8 mm

99 Double Flange 1976+

65-11 65-20 65-30 65-40

65-M0

**65-K0**  
Complete kit

ALU Quality

Pipe diameter: 50,8 mm  
Tailpipe: Round 50,8 mm

900 Turbo 8V/16V 79-88

Original 61-3 61-4 61-5

61-M

**61-H**  
Complete kit fits to original pipework

ALU Quality

Pipe diameter: 63,5 mm  
Tailpipe: 2 x Round 57 mm - Brushed

900 Turbo 8V/16V 81-91  
(for models without a catalyst fitted as standard)

61-1 61-2 61-3 61-4 61-5

61-M

**61-K**  
Complete kit

ALU Quality

Pipe diameter: 63,5 mm  
Tailpipe: 2 x Round 57 mm - Brushed



900 Turbo (with catalyst) 87-93

Original

61-3 61-42 61-52

61-M2

**61-H2** ALU Quality

Complete kit fits to connection pipe

Pipe diameter: 63,5 mm  
Tailpipe: Oval 70/90 mm

900i 2.0/2.3 Coupé/Cabrio 94+

Original

63-3 63-4 63-5

63-MH

**63-H** TOP Quality

Complete kit fits to cat/flexible part

Pipe diameter: 63,5 mm  
Tailpipe: Round 90 mm

900 2.0T Coupé/Cabrio 94+

Original

63-3 63-4 63-55

63-MH

**63-H5** TOP Quality

Complete kit fits to cat/flexible part

Pipe diameter: 63,5 mm  
Tailpipe: Round 90 mm

9-3 2.0T Coupé/Cabrio 98-02  
(Not for Viggen or Aero)

Original

63-3 63-4 63-56

\*Optional Extra 63-29R  
\*Replaces OE flexipipe

63-MH

**63-H6** TOP Quality

Complete kit fits to OE flexible part\*

Pipe diameter: 63,5 mm  
Tailpipe: Oval 70/140 mm

9-3 Viggen 9-3 Aero Ver. II 01-02

Original

63-3 63-4 63-57

\*Optional Extra 63-29R  
\*Replaces OE flexipipe

63-MH

**63-H7** TOP Quality

Complete kit fits to OE flexible part\*

Pipe diameter: 63,5 mm  
Tailpipe: Oval 70/140 mm

9-3 Aero Ver. I Year 2000  
(Also fits turbo models with original sports spoiler)

Original

63-3 63-4 63-58

\*Optional Extra 63-29R  
\*Replaces OE flexipipe

63-MH

**63-H8** TOP Quality

Complete kit fits to OE flexible part\*

Pipe diameter: 63,5 mm  
Tailpipe: Oval 70/140 mm

9-3 1.8T/2.0T SportSaloon/Wagon/Cabriolet 03+ \*\*  
 9-3 2.0T Aero SportSaloon/Wagon/Cabriolet 03+  
 (Big fuel tank 61L) + Biopower

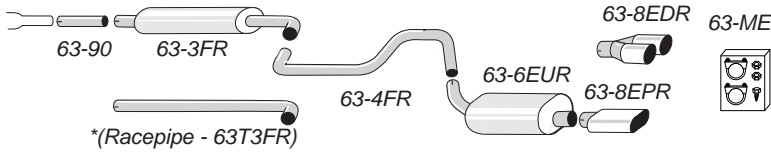

\*Replaces front silencer 63-3FR. \*\* Can be used for non-Aero models if the bumper is trimmed or replaced.

**63-HFPR/TR\***  
**63-HFDR/TR\***



Complete kit fits to OE flexible part



Pipe diameter: 63,5 mm  
 Tailpipe: Oval 85/150 mm or Twin Round 80 mm

9-3 1.8T/2.0T/2.8T SportSaloon/Wagon/Cabriolet 03+  
 (Big fuel tank 61L) + Biopower

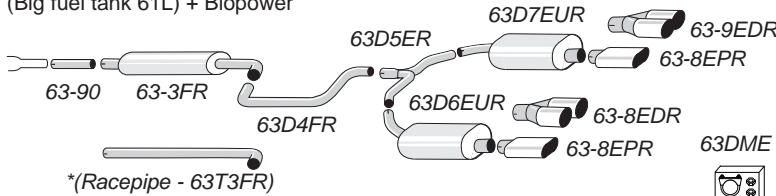

\*Replaces front silencer 63-3FR. For models with no tailpipe on the right side, use hanger kit 63FTH. Spoiler must be trimmed for right sided tailpipe where no cutout exists.

**63DHFPR/TR\***  
**63DHFDR/TR\***



Complete kit fits to OE flexible part



Pipe diameter: 63,5 mm + 2x54 mm  
 Tailpipe: Duplex Oval 85/150 mm/Quad Round 80 mm

9-3 2.8T/2.0T Aero SportSaloon/Wagon/Cabriolet 06+  
 (Big fuel tank 61L) + Biopower  
 For models with OE tailpipes left and right

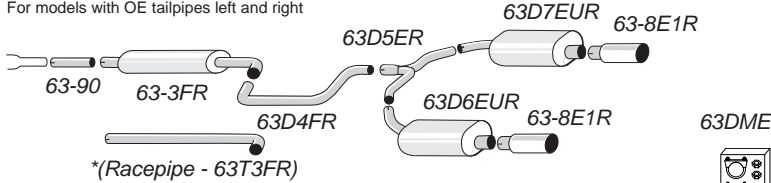

\*Replaces front silencer 63-3FR. With the addition of hanger kit 63FTH, the kit can also be used to non Aero 1.8T/2.0T 2003+ models if the spoiler is trimmed.

**63DHFR/TR\***



Complete kit fits to OE flexible part



Pipe diameter: 63,5 mm + 2x54 mm  
 Tailpipe: Duplex Round 100 mm

9-3 2.0T Aero SportSaloon/Wagon/Cabriolet 2004-05  
 9-3 1.8T/2.0T SportSaloon/Wagon/Cabriolet 2004+ \*\*  
 (Small fuel tank 58L) + Biopower

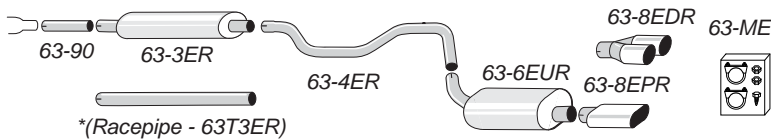

\*Replaces front silencer 63-3ER. \*\* Can be used for non-Aero models if the bumper is trimmed or replaced.

**63-HEPR/TR\***  
**63-HEDR/TR\***



Complete kit fits to OE flexible part



Pipe diameter: 63,5 mm  
 Tailpipe: Oval 85/150 mm or Twin Round 80 mm

9-3 1.8T/2.0T/2.8T SportSaloon/Wagon/Cabriolet 04+  
 (Small fuel tank 58L) + Biopower

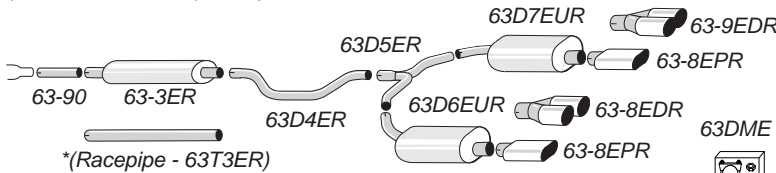

\*Replaces front silencer 63-3ER. For models with no tailpipe on the right side, use hanger kit 63FTH. Spoiler must be trimmed for right sided tailpipe where no cutout exists.

**63DHEPR/TR\***  
**63DHEDR/TR\***



Complete kit fits to OE flexible part



Pipe diameter: 63,5 mm + 2x54 mm  
 Tailpipe: Duplex Oval 85/150 mm/Quad Round 80 mm

9-3 2.8T/2.0T Aero SportSaloon/Wagon/Cabriolet 06+  
 (Small fuel tank 58L) + Biopower

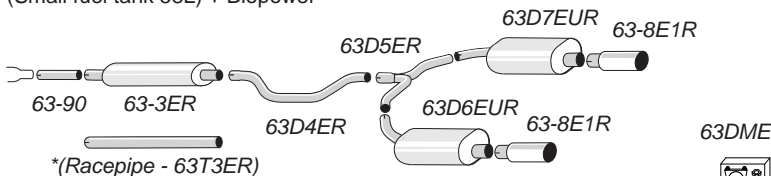

\*Replaces front silencer 63-3ER. With the addition of hanger kit 63FTH, the kit can also be used to non Aero 1.8T/2.0T 2004+ models if the spoiler is trimmed.

**63DHER/TR\***



Complete kit fits to OE flexible part



Pipe diameter: 63,5 mm + 2x54 mm  
 Tailpipe: Duplex Round 100 mm

## IMPORTANT FITTING INFORMATION

The following information is relevant for Saab 9-3 models manufactured from 2003 onwards. In order that the correct exhaust is fitted, please decide on whether the vehicle has a small or large fuel tank. This is determined by checking the pathway of the exhaust pipework as shown in the images below.

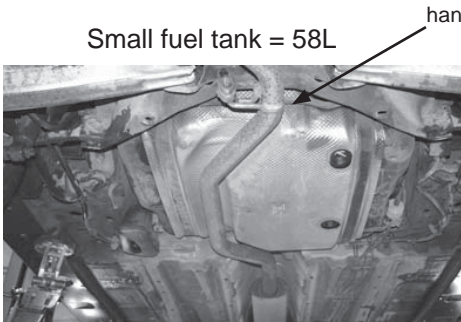

Small fuel tank = 58L

hanger

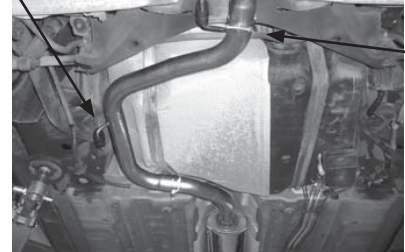

Big fuel tank = 61L

hanger

### Information SAAB 9-3 2003+ Fuel tanks

9000 CS Turbo 2.0/2.3/Aero 92+

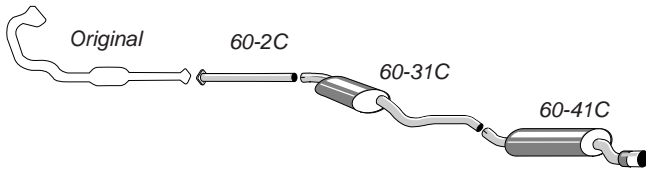

60-MH



## 60-H1C

Complete kit fits to OE flexible part



Pipe diameter: 63,5 mm  
Tailpipe: Round 90 mm

9-5 Turbo 2.0/2.3 Saloon/Estate  
9-5 Aero Saloon/Estate

98-01  
98-03

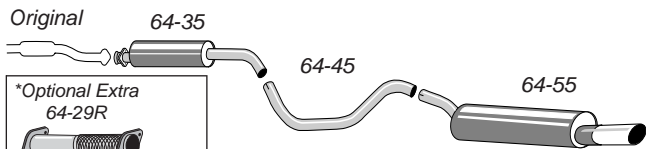

64-M5



## 64-H5

Complete kit fits to OE flexible part\*



Pipe diameter: 63,5 mm  
Tailpipe: Oval 90/120 mm

\*Optional Extra 64-29R  
\*Replaces OE flexipipe

64-H5 Can be used for non aero models 02-05 if the spoiler is trimmed.

9-5 Turbo 2.0/2.3 Saloon/Estate

02-10

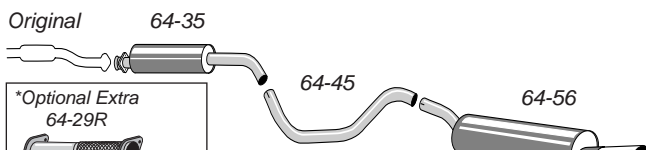

64-M5



## 64-H6

Complete kit fits to OE flexible part\*



Pipe diameter: 63,5 mm  
Tailpipe: Oval 90/120 mm

\*Optional Extra 64-29R  
\*Replaces OE flexipipe

For vehicles without a cut out in the spoiler.  
64-H5/64-H7/64DH6/64DH7 can be used if the spoiler is trimmed.

9-5 Turbo 2.0/2.3 Saloon/Estate  
9-5 Aero Saloon/Estate

98-05  
98-03

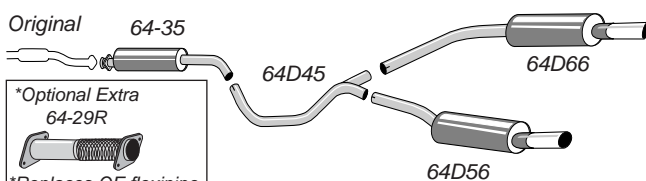

64DM6



## 64DH6

Complete kit fits to OE flexible part\*



Pipe diameter: 63,5 mm  
Tailpipe: Duplex Oval 90/120 mm

\*Optional Extra 64-29R  
\*Replaces OE flexipipe

The spoiler must be trimmed.



9-5 Turbo 2.0/2.3 Saloon/SportsWagon 06-10  
9-5 Aero Saloon/Estate 04-10

Original 64-35 64-45 64-57

\*Optional Extra 64-29R

\*Replaces OE flexipipe

64-M5

## 64-H7

Complete kit fits to OE flexible part\*

Pipe diameter: 63,5 mm  
Tailpipe: Oval 90/120 mm

9-5 Turbo 2.0/2.3 Saloon/SportsWagon 06-10  
9-5 Aero Saloon/Estate 04-10

Original 64-35 64D45 64D67 64D57

\*Optional Extra 64-29R

\*Replaces OE flexipipe

64DM6

*The spoiler must be trimmed on non Aero models.*

## 64DH7

Complete kit fits to OE flexible part\*

Pipe diameter: 63,5 mm  
Tailpipe: Duplex Oval 90/120 mm

**Leon 1.8i Turbo 99-05**

Original 41-20R 41-3R 41-46R 41-M6

\*(Racepipe - T41T2R)

\*Replaces front silencer 41-20R.

**41-H6R<sup>EC</sup> /TR\***

Complete kit fits to catalyst  
\*non-resonated option (no approval)

Pipe diameter: 63,5 mm  
Tailpipe: 2 x Round 80 mm

**Leon 1.2TSi/1.4TSi/1.8TSi/2.0TFSi/TSi/Cupra/Cupra R 05+**

Original 40-25R 40-35R 40-45R 40-56WR 40-M5

\*(Racepipe - 40T35R)

\* Replaces front silencer 40-35R.

**40-H6WR<sup>EC</sup> /TR\***

Complete kit fits to catalyst  
\*non-resonated option (no approval)

Pipe diameter: 76 mm  
Tailpipe: Oval 90/140 mm

**Leon 1.2TSi/1.4TSi/1.8TSi/2.0TFSi/TSi/Cupra/Cupra R 05+**

Original 40-25R 40-35R 40D45R 40D56WR 40DM5

\*(Racepipe - 40T35R)

\*Replaces front silencer 40-35R. The spoiler must be trimmed for the right side tailpipe.

**40DH6WR<sup>EC</sup> /TR\***

Complete kit fits to catalyst  
\*non-resonated option (no approval)

Pipe diameter: 76 mm  
Tailpipe: Duplex Oval 90/140 mm

**Leon 1.2TSi/1.4TSi/1.8TSi/2.0TFSi/TSi/Cupra/Cupra R 05+**

Original 40-25R 40-35R 40D45R 40D561R 40DM5

\*(Racepipe - 40T35R)

\*Replaces front silencer 40-35R. The spoiler must be trimmed for the right side tailpipe.

**40DH61R<sup>EC</sup> /TR\***

Complete kit fits to catalyst  
\*non-resonated option (no approval)

Pipe diameter: 76 mm  
Tailpipe: Duplex Round 100 mm

**Leon 1.2TSi/1.4TSi/1.8TSi/2.0TFSi/TSi/Cupra/Cupra R 05+**

Original 40-25R 40-35R 40D45R 40D66DR 40D56DR 40DM5

\*(Racepipe - 40T35R)

\*Replaces front silencer 40-35R. The spoiler must be trimmed for the right side tailpipes.

**40DH6DR<sup>EC</sup> /TR\***

Complete kit fits to catalyst  
\*non-resonated option (no approval)

Pipe diameter: 76 mm  
Tailpipe: Quad Round 80 mm

**Leon Cupra (5F) 2WD Hatchback 265-310bhp 2013+**

Original 4A-2GR 4A-35R 4AD45R 4AD56DR 4AD66DR 40DMGR

\*(Racepipe - 4AT2GR)

\*Replaces front silencer 4A-2GR. For spoiler with original oval/double tailpipes.

**4ADH6DR<sup>EC</sup> /TR\***

Complete kit fits to OE Downpipe  
\*non-resonated option (no approval)

Pipe diameter: 76 mm  
Tailpipe: Quad Round 80 mm

Leon Cupra (5F) 2WD Hatchback 265-310bhp 2013+

Original

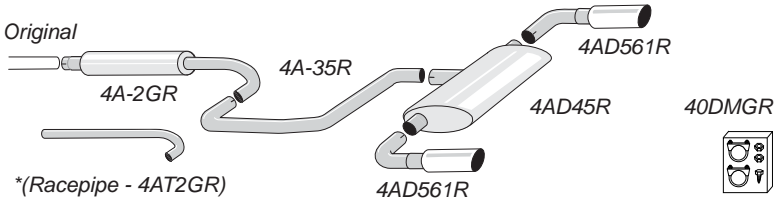

\*(Racepipe - 4AT2GR)

\*Replaces front silencer 4A-2GR. For spoiler with original round tailpipes.

## 4ADH61R<sup>EC</sup> /TR\*

Complete kit fits to OE Downpipe

\*non-resonated option (no approval)



Pipe diameter: 76 mm

Tailpipe: Duplex Round 100 mm





Octavia 1.8 Turbo vRS Saloon/Estate 02-04

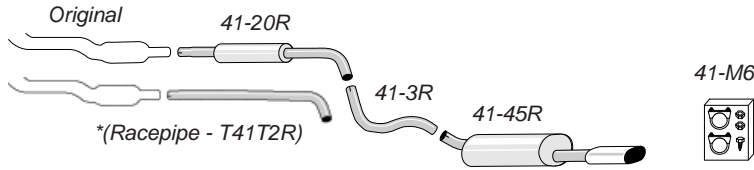

\*Replaces front silencer 41-20R.  
The system can be fitted to other models than RS if the spoiler is changed or trimmed.

## 41-H5R<sup>EC</sup> /TR<sup>\*</sup>

Complete kit fits to catalyst  
\*non-resonated option (no approval)



Pipe diameter: 63,5 mm  
Tailpipe: Oval 85/150 mm



Octavia 1.8 Turbo vRS Saloon/Estate 02-04

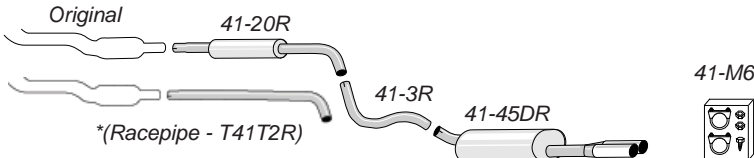

\*Replaces front silencer 41-20R.  
The system can be fitted to other models than RS if the spoiler is changed or trimmed.

## 41-H5DR<sup>EC</sup> /TR<sup>\*</sup>

Complete kit fits to catalyst  
\*non-resonated option (no approval)



Pipe diameter: 63,5 mm  
Tailpipe: 2 x Round 80 mm



Octavia RS 2.0TFSi/TSI Saloon/Estate 06-

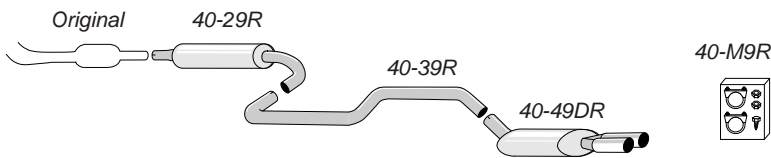

## 40-H9DR<sup>EC</sup>

Complete kit fits to catalyst



Pipe diameter: 76 mm  
Tailpipe: 2 x Round 80 mm



Impreza Turbo (Classic) 93-00

Original  
TSA-20R  
TSA-30R  
TSA-40R  
TSA-511R

TSA-M0

**TSA-H11R**

Complete kit replaces second catalyst

Pipe diameter: 76 mm  
Tailpipe: Round 100 mm

Impreza Turbo (Classic) 93-00

Downpipe fits to OE exhaust or Jetex system TSA-H11R

**TSAT10R**

De-cat flanged downpipe fits to turbo.  
**Not e-marked.**

Pipe diameter: 76 mm

Impreza Turbo (New Age) 00-07

Original  
TSA-28R  
TSA-38R  
TSA-481R

TSA-M8

**TSA-H81R**

Complete kit fits to catalyst

Pipe diameter: 76 mm  
Tailpipe: Round 100 mm

**Insignia Diesel 2WD 4/5 Doors 2.0D**  
(81kW/110bhp-96kW/130bhp-118kW/160bhp)  
Only for engines with particle filter

09+  
81D6AZR

81D4AR

81D5AZR

81-2AR

81-3AR

81DMHA

The diffuser must be trimmed or replaced by the diffuser from a petrol turbo car. If no hanger for driver's side silencer, fitting kit 81D6AFT must be used.

**81DHAZR<sup>EC</sup>**

Complete kit fits to original downpipe

Pipe diameter: 63,5 mm + 2x54 mm  
Tailpipe: Duplex Oval 90/120 mm

**Insignia Diesel 2WD 4/5 Doors 2.0D**  
(81kW/110bhp-96kW/130bhp-118kW/160bhp)  
Only for engines with particle filter

09+  
81D6AZR

81D4AR

81D5AZR

Original

82DMBA

The diffuser must be trimmed or replaced by the diffuser from a petrol turbo car. If no hanger for driver's side silencer, fitting kit 81D6AFT must be used.

**81DBAZR<sup>EC</sup>**

Back silencers with Y-piece

Pipe diameter: 63,5 mm + 2x54 mm  
Tailpipe: Duplex Oval 90/120 mm

**(Opel) Manta B Hatch**

Original

84-2

84-31

84-4

84-MH

84-2 will fit to an original Jetex downpipe or has to be modified to suit the original or custom downpipe

**84-H1<sup>EC</sup>**

Half System

Pipe diameter: 50,8 mm  
Tailpipe: Round 80 mm

ALU Quality

**(Opel) Manta B Coupe**

Original

84-2

84-3

84-4

84-MH

84-2 will fit to an original Jetex downpipe or has to be modified to suit the original or custom downpipe

**84-H<sup>EC</sup>**

Half System

Pipe diameter: 50,8 mm  
Tailpipe: Round 80 mm

ALU Quality



**New Beetle 1.8T/2.0**

*\*(Replaces front silencer 41-2R.)*

41-M

**41-HR<sup>EC</sup> /TR<sup>\*</sup>**

Complete kit fits to catalyst  
\*non-resonated option (no approval)

Pipe diameter: 63,5 mm  
Tailpipe: 2 x Round 80 mm

**New Beetle 1.8T**

*\*(Replaces front silencer 41-20R. For tuning - extra low back pressure.)*

41-M0

**41-H0R<sup>EC</sup> /TR<sup>\*</sup>**

Complete kit fits to catalyst  
\*non-resonated option (no approval)

Pipe diameter: 63,5 mm  
Tailpipe: 2 x Round 80 mm

**Corrado 1.8 16V**      -7/91    up to chassis 50-M-021 000  
**Corrado G60**        -7/91    up to chassis 50-M-021 000

*\*(Replaces front silencer 28-2R. Exhaust fits models with HOOK hangers.)*

28-M71

**28-H71R<sup>EC</sup> /TR<sup>\*</sup>**

Complete kit fits to catalyst  
\*non-resonated option (no approval)

Pipe diameter: 63,5 mm  
Tailpipe: Oval 90/120 mm

**Corrado 1.8 16V**      8/91+    from chassis 50-N-000 0001  
**Corrado 2.0 8V/16V**  
**Corrado G60**         8/91+    from chassis 50-N-000 0001  
**Corrado 2.9 VR6**

*\*(Replaces front silencer 26-2R. Exhaust fits models with BAR hangers)*

26-MH

**26-H7R<sup>EC</sup> /TR<sup>\*</sup>**

Complete kit fits to catalyst  
\*non-resonated option (no approval)

Pipe diameter: 63,5 mm  
Tailpipe: Oval 90/120 mm

**Golf Mk1 GTi/Cabrio**    74-83  
**(also Scirocco Mk1 74-83)**

29-M0

**29-H<sup>EC</sup>**

Complete kit fits to cat/downpipe

Pipe diameter: 50,8 mm  
Tailpipe: Round 80 mm

**Golf Mk1 GTi/Cabrio (not clipper)**    74-83  
**(also Scirocco Mk1 74-83)**

29-M0

**29-HR<sup>EC</sup>**

Complete kit fits to cat/downpipe

Pipe diameter: 50,8 mm  
Tailpipe: Round 80 mm

**Golf Mk1 GTi/Cabrio (not clipper) 74-83**  
(also Scirocco Mk1 74-83)

For tuning - extra low back pressure.

**T29-H6R**  
Complete kit fits to cat/downpipe

Pipe diameter: 63,5 mm  
Tailpipe: Round 80 mm

**Golf Mk1 Cabrio (not clipper) 84+**  
(also Scirocco Mk2 84+)

Fitting kit includes extra bracket and hanger.

**29-H2<sup>EC</sup>**  
Complete kit fits to cat/downpipe

Pipe diameter: 50,8 mm  
Tailpipe: Round 80 mm

**Golf Mk1 Cabrio (not clipper) 84+**  
(also Scirocco Mk2 84+)

Fitting kit includes extra bracket and hanger.

**29-H2R<sup>EC</sup>**  
Complete kit fits to cat/downpipe

Pipe diameter: 50,8 mm  
Tailpipe: Round 80 mm

**Golf Mk1 Cabrio 1.3-1.8 1/84-88**  
(also Scirocco Mk2 1.3-1.8 84-92)  
With or without catalystr

**29-H8R<sup>EC</sup>**  
Complete kit fits to cat/downpipe

Pipe diameter: 63,5 mm  
Tailpipe: 2 x Oval 70/90 mm

**Golf Mk2 1.3/1.6/1.8 8V/GTi 9/83-91**  
With or without catalystr

\*(Racepipe - U015100R)

\*Replaces front silencer 31-2R.  
On some models (Driver) the spoiler must be slightly trimmed to fit the double tailpipes.

**31-H2R/TR\***  
Complete kit fits to cat/original pipework  
\*non-resonated option

Pipe diameter: 50,8 mm  
Tailpipe: 2 x Round 80 mm

**Golf Mk2 GTi 16V 85-91**  
With or without catalystr

\*(Racepipe - U016300R)

\*Replaces front silencer 28-2R.

**28-HR<sup>EC</sup>/TR\***  
Complete kit fits to cat/front silencer  
\*non-resonated option (no approval)

Pipe diameter: 63,5 mm  
Tailpipe: 2 x Round 80 mm

Golf Mk3 1.4/1.6/1.8/1.9D/1.9TD/1.9TDI/2.0/2.8 VR6 6/91-97

*\*(Racepipe - 26T2R)*

*\*Replaces front silencer 26-2R.*

## 26-HR<sup>EC</sup>/TR\*

Complete kit fits to catalyst  
\*non-resonated option (no approval)

Pipe diameter: 63,5 mm  
Tailpipe: 2 x Round 80 mm

Golf Mk3 2.0L 8V (GTi/2E/ADY/AGG) 8/93-8/98  
Golf Mk3 2.0L 16V (ABF) 8/93-11/97  
Golf Mk3 2.8L VR6 (AAA) 8/93-12/97

*Fits to OE 3-bolt flange  
Compatible with OE or Jetex cat-back system*

## T26-12R

Cat replacement pipe

**Vehicles from 1992+ must have a cat fitted for MOT purposes.**

Pipe diameter: 63,5 mm

Golf Mk4 1.4/1.6/1.8/1.8T/1.9TDI/1.9SDI/2.0/2.3 V5 96+

*\*(Racepipe - T41T2R)*

*\*Replaces front silencer 41-2R.*

## 41-HR<sup>EC</sup>/TR\*

Complete kit fits to catalyst  
\*non-resonated option (no approval)

Pipe diameter: 63,5 mm  
Tailpipe: 2 x Round 80 mm

Golf Mk4 Turbo 1.8T/1.9TDI/1.9SDI 96+

*\*(Racepipe - T41T2R)*

*\*Replaces front silencer 41-2R. For tuning - extra low back pressure.*

## 41-H0R<sup>EC</sup>/TR\*

Complete kit fits to catalyst  
\*non-resonated option (no approval)

Pipe diameter: 63,5 mm  
Tailpipe: 2 x Round 80 mm

Golf Mk4 Turbo 1.8T/1.9TDI/1.9SDI 96+

*\*(Racepipe - T41T2R)*

*\*Replaces front silencer 41-20R. For tuning - extra low back pressure.  
Tailpipes exit through the spoiler. The spoiler must be trimmed or replaced by the spoiler for the V6 model.*

## 41SH0DR<sup>EC</sup>/TR\*

Complete kit fits to catalyst  
\*non-resonated option (no approval)

Pipe diameter: 63,5 mm  
Tailpipe: 2 x Round 80 mm

Golf Mk4 V6 4Motion 150kW/204bhp 96+

*\*(Racepipe - 41T38R)*

*\*Replaces front silencer 41-38R.*

## 41-HCR<sup>EC</sup>/TR\*

Complete kit fits to catalyst  
\*non-resonated option (no approval)

Pipe diameter: 70 mm  
Tailpipe: Oval 85/150 mm



**Golf Mk4 R32 177kW/240bhp**

Original 41-3ER 41-4ER 41-5E1R 41-ME

41-5E1R

**41-HER<sup>EC</sup>**

Complete kit fits to catalyst

Pipe diameter: 70 mm  
Tailpipe: Duplex Round 100 mm

Golf Mk5 2.0TFSi GTi/Edition 30 04+  
Golf Mk5 1.4 16V 66kW/1.6FSi 16V 85kW 04+  
Golf Mk5 1.4TSi/1.4TSi GT 07+  
Golf Mk6 1.4TSi/1.8TSi 09+

Original 40-25R 40-35R 40-45R 40-M5

40-55R

\*(Racepipe - 40T35R)

\*Replaces front silencer 40-35R. Spoiler without a cutout for the tailpipe must be trimmed.

**40-H51R<sup>EC</sup> /TR\***

Complete kit fits to catalyst

\*non-resonated option (no approval)

Pipe diameter: 76 mm  
Tailpipe: Round 100 mm

Golf Mk5 2.0TFSi GTi/Edition 30 04+  
Golf Mk5 1.4 16V 66kW/1.6FSi 16V 85kW 04+  
Golf Mk5 1.4TSi/1.4TSi GT 07+  
Golf Mk6 1.4TSi/1.8TSi 09+

Original 40-25R 40-35R 40-50R 40DM5

40D45R 40-50R

\*(Racepipe - 40T35R)

\*Replaces front silencer 40-35R. Spoiler without a cutout for the tailpipes must be trimmed.

**40DH51R<sup>EC</sup> /TR\***

Complete kit fits to catalyst

\*non-resonated option (no approval)

Pipe diameter: 76 mm + 2x63,5 mm  
Tailpipe: Duplex Round 100 mm

Golf Mk5 2.0TFSi GTi/Edition 30 04+  
Golf Mk5 1.4 8V/16V/1.6FSi/1.9TDi/2.0SDi 04+  
Golf Mk5 1.4TSi/1.4TSi GT 07+  
Golf Mk6 1.4TSi/1.8TSi 09+

Original 40-95BR 40-60DR 40DM5

40D45R 40-50DR

The spoiler must be trimmed.

**40DB5DR<sup>EC</sup>**

Back box

Pipe diameter: 76 mm + 2x63,5 mm  
Tailpipe: Quad Round 80 mm

Golf Mk5 2.0TFSi GTi/Edition 30 04+  
Golf Mk5 1.4 16V 66kW/1.6FSi 16V 85kW 04+  
Golf Mk5 1.4TSi/1.4TSi GT 07+  
Golf Mk6 1.4TSi/1.8TSi 09+

Original 40-25R 40-35R 40-60DR 40DM5

40D45R 40-50DR

\*(Racepipe - 40T35R)

The spoiler must be trimmed.

**40DH5DR<sup>EC</sup> /TR\***

Complete kit fits to catalyst

\*non-resonated option (no approval)

Pipe diameter: 76 mm + 2x63,5 mm  
Tailpipe: Quad Round 80 mm

Golf Mk5 2.0TFSi GTi/Edition 30 04+  
Golf Mk5 1.4 8V/16V/1.6FSi/1.9TDi/2.0SDi 04+  
Golf Mk5 1.4TSi/1.4TSi GT 07+  
Golf Mk6 1.4TSi/1.8TSi 07+

Original 40-95BR 40-45R 40-M5B

40-55DR

**40-B5DR<sup>EC</sup>**

Back Box

Pipe diameter: 76 mm  
Tailpipe: 2 x Round 80 mm

Golf Mk5 2.0TFSi GTi/Edition 30	04+
Golf Mk5 1.4 16V 66kW/1.6FSi 16V 85kW	04+
Golf Mk5 1.4TSi/1.4TSi GT	07+
Golf Mk6 1.4TSi/1.8TSi	09+

## 40-H5DR<sup>EC</sup> /TR<sup>\*</sup>

Complete kit fits to catalyst  
\*non-resonated option (no approval)

Pipe diameter: 76 mm  
Tailpipe: 2 x Round 80 mm

Golf Mk5 1.4 16V 55kW	04+
Golf Mk5 1.6FSi 8V 75kW	04+
Golf Mk5 1.9TDi/2.0SDi	03+

For the models above, it is possible to fit the following part numbers:  
40-H51R/TR, 40-H5DR/TR, 40DH5DR/TR, 40DH51R/TR with the use of adaptor 40-259R.

## Notes for: VW Golf Mk5/6 1.4/1.6 Petrol and 1.9/2.0 Diesel Engines.

Golf Mk6 GTi 2.0TSi 211bhp	09-
----------------------------	-----

## 40DHG1R<sup>EC</sup> /TR<sup>\*</sup>

Complete kit fits to catalyst  
\*non-resonated option (no approval)

Pipe diameter: 76 mm  
Tailpipe: Duplex Round 100 mm

Golf Mk6 R 270bhp	
-------------------	--

## 40DHS1R

Complete kit fits to catalyst

Pipe diameter: 76 mm + 2x57 mm  
Tailpipe: Duplex Round 100 mm

Golf Mk7 1.2TSI (for multilink or torsion beam)	12+
Golf Mk7 1.4TSI	12+

## 4A-H5DR<sup>EC</sup> /TR<sup>\*</sup>

Complete kit fits to downpipe  
\*non-resonated option (no approval)

Pipe diameter: 76 mm  
Tailpipe: 2 x Round 80 mm

Golf Mk7 1.2TSI (for torsion beam suspension)	12+
---	-----

## 4A-B5DR<sup>EC</sup>

Back Box

Pipe diameter: 76 mm  
Tailpipe: 2 x Round 80 mm

Golf Mk7 1.2TSI (for multilink or torsion beam) 12+  
 Golf Mk7 1.4TSI 12+ 4AD65DR

4A-25R 4A-35R (or 4A-33R for torsion beam) 4AD45R  
 Original 4AD55DR 4ADM5R

\*(Racepipe - 4AT25R)

The spoiler must be trimmed for right side tailpipe.

**4ADH5DR<sup>EC</sup>/TR\***

Complete kit fits to downpipe  
 \*non-resonated option (no approval)

Pipe diameter: 76 mm + 2x63,5 mm  
 Tailpipe: Quad Round 80 mm

Golf Mk7 1.2TSI (for torsion beam suspension) 12+

4A-95AR 4AD65DR 4AD45R 4ADM5R  
 4AD55DR

The spoiler must be trimmed for right side tailpipe.

**4ADB5DR**

Back Box

Pipe diameter: 76 mm + 2x63,5 mm  
 Tailpipe: Quad Round 80 mm

Golf Mk7 GTI 2.0TSI 220bhp 12+  
 (+ Performance Pack 230bhp models)

4A-2GR 4A-35R 4AD5G1R 4AD45R 4ADMG1R  
 Original 4AD55DR

\*(Racepipe - 4AT2GR)

**4ADHG1R/TR\***

Complete kit fits to downpipe  
 \*Resonated or non-resonated option

Pipe diameter: 76 mm + 2x63,5 mm  
 Tailpipe: Duplex Round 100 mm

Golf Mk7 R 2013-17

4B-95R 4B-35R 4BD55DR 4BD75DR 4BD45R 4ADM5  
 \*4BT35R 4BD55DR 4BD65DR

\* Replaces front silencer 4B-35R

**4BDH5DR/TR\***

Complete kit fits to downpipe  
 \*Resonated or non-resonated option

Pipe diameter: 76 mm + 2x63,5 mm  
 Tailpipe: Quad Round 90 mm

Jetta Mk5 1.4/2.0 TFSi 05+

Original 40-29R 40-39R 40-49DR 40-M9R

**40-H9DR<sup>EC</sup>**

Complete kit fits to catalyst

Pipe diameter: 76 mm  
 Tailpipe: 2 x Round 80 mm

Passat (B6/3C) Saloon/Estate/CC 2.0 TFSi 05-10  
 Passat (B6/3C) Saloon/Estate/CC 1.8TSI 05-10

Original 40-2ER 40-3ER 40-4EDR 40-ME

**40-HEDR<sup>EC</sup>**

Complete kit fits to catalyst

Pipe diameter: 76 mm  
 Tailpipe: 2 x Round 80 mm



Scirocco Mk1 74-83  
(also Golf Mk1 GTi/Cabrio 74-83)

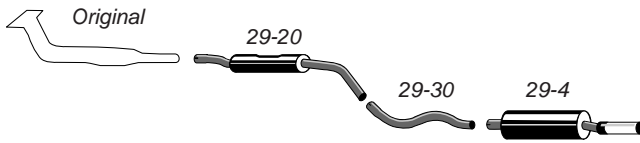

29-M0



## 29-H<sup>EC</sup>

Complete kit fits to cat/downpipe



Pipe diameter: 50,8 mm  
Tailpipe: Round 80 mm

ALU Quality



Scirocco Mk1 74-83  
(also Golf Mk1 GTi/Cabrio 74-83)

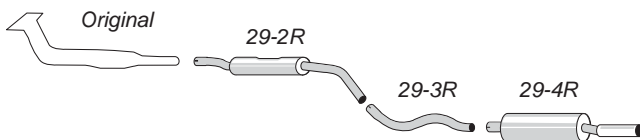

29-M0



## 29-HR<sup>EC</sup>

Complete kit fits to cat/downpipe



Pipe diameter: 50,8 mm  
Tailpipe: Round 80 mm



Scirocco Mk1 74-83  
(also Golf Mk1 GTi/Cabrio 74-83)

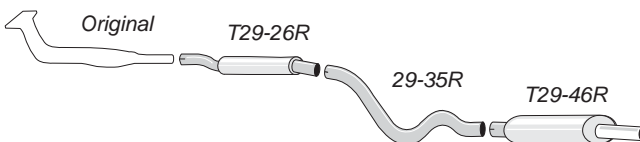

T29-M6



## T29-H6R

Complete kit fits to cat/downpipe



Pipe diameter: 63,5 mm  
Tailpipe: Round 80 mm



Scirocco Mk2 84+  
(also Golf Mk1 Cabrio 84+)

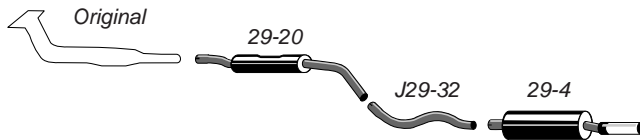

29-M0



## 29-H2<sup>EC</sup>

Complete kit fits to cat/downpipe



Pipe diameter: 50,8 mm  
Tailpipe: Round 80 mm

ALU Quality



Scirocco Mk2 84+  
(also Golf Mk1 Cabrio 84+)

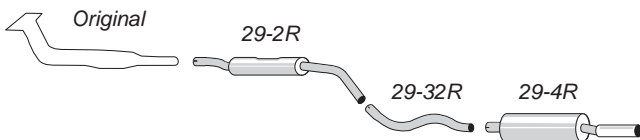

29-M0



## 29-H2R<sup>EC</sup>

Complete kit fits to cat/downpipe



Pipe diameter: 50,8 mm  
Tailpipe: Round 80 mm



Scirocco Mk2 1.3-1.8 84-92  
(also Golf Mk1 Cabrio 1.3-1.8 1/84-88)  
With or without catalst

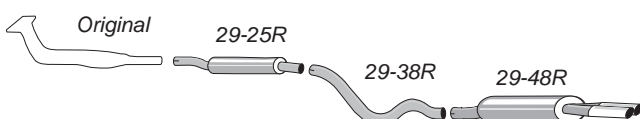

29-M8



## 29-H8R<sup>EC</sup>

Complete kit fits to cat/downpipe



Pipe diameter: 63,5 mm  
Tailpipe: 2 x Oval 70/90 mm



Scirocco Mk3 1.4TSI/2.0TSi/TFsi 09-14

*\*(Racepipe - 40T35R)*

*\*Replaces front silencer 40-35R.*

**40-H7DR<sup>EC</sup> /TR<sup>\*</sup>**

Complete kit fits to catalyst  
\*non-resonated option (no approval)

Pipe diameter: 76 mm  
Tailpipe: 2 x Round 80 mm

Scirocco Mk3 1.4TSI/2.0TSi/TFsi 09-14

*\*(Racepipe - 40T35R)*

*\*Replaces front silencer 40-35R. Spoiler must be trimmed for right side tailpipes.*

**40DH7DR<sup>EC</sup> /TR<sup>\*</sup>**

Complete kit fits to catalyst  
\*non-resonated option (no approval)

Pipe diameter: 76 mm  
Tailpipe: Quad Round 80 mm

<p>Amazon 1961-66 Saloon (Single Hole Flange)</p>	<p><b>25-K1</b> Complete kit</p> <p>ALU Quality</p> <p>Pipe diameter: 50,8 mm Tailpipe: Round 70 mm</p>
<p>Amazon 1967-70 Saloon (Double Hole Flange)</p>	<p><b>25-K</b> Complete kit</p> <p>ALU Quality</p> <p>Pipe diameter: 50,8 mm Tailpipe: Round 70 mm</p>
<p>Amazon 1961-66 Estate (Double Hole Flange)</p>	<p><b>25-K3</b> Complete kit</p> <p>ALU Quality</p> <p>Pipe diameter: 50,8 mm Tailpipe: Round 70 mm</p>
<p>Amazon 1967+ Estate (Double Hole Flange)</p>	<p><b>25-K2</b> Complete kit</p> <p>ALU Quality</p> <p>Pipe diameter: 50,8 mm Tailpipe: Round 70 mm</p>
<p>140-Series B18/B20 A/B/D/E 1967-73</p>	<p><b>71-K</b> Complete kit</p> <p>ALU Quality</p> <p>Pipe diameter: 54 mm Tailpipe: Round 54 mm</p>
<p>240-Series 240/242/244/245 Turbo B21/B23 1981+ (without catalyst)</p>	<p><b>70-K</b> Complete kit</p> <p>ALU Quality</p> <p>Pipe diameter: 63,5 mm Tailpipe: Round 90 mm</p>



240-Series 240/242/244/245 B17/B19/B21/B23 1976-88  
(without catalyst)

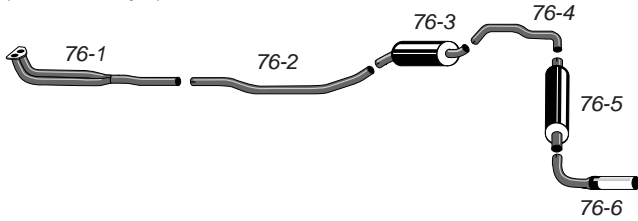

## 76-K

Complete kit

ALU Quality



Pipe diameter: 2x45 mm then 54 mm  
Tailpipe: Round 80 mm

240-Series 240/242/244/245 B17/B19/B21/B23 1985+  
(with catalyst)

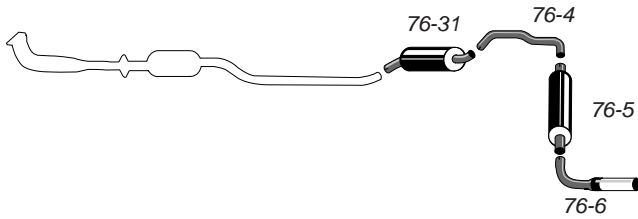

## 76-H

Half System - Fits to catalyst

ALU Quality



Pipe diameter: 54 mm  
Tailpipe: Round 80 mm

740/940 Saloon/Estate GL/GLE/GLT 1985+  
(4-cyl non-turbo with catalyst)



## 75-H68

Half System - Fits to catalyst



Pipe diameter: 63,5 mm  
Tailpipe: Round 80 mm

740/940 Saloon/Estate GL/GLE/GLT 1985+  
(4-cyl non-turbo with catalyst)



## 75-H6

Half System - Fits to catalyst



Pipe diameter: 63,5 mm  
Tailpipe: Twin Round 70 mm

Diffuser must be trimmed on 740 models to suit twin tailpipes

740/760/940 Saloon/Estate GL/GLE/GLT 1985+  
(4-cyl turbo with catalyst - not multilink models)



## 24-H6

Half System - Fits to catalyst



Pipe diameter: 63,5 mm  
Tailpipe: Round 80 mm

740/940 Saloon/Estate GL/GLE/GLT 1985+  
(4-cyl turbo with catalyst - not multilink models)

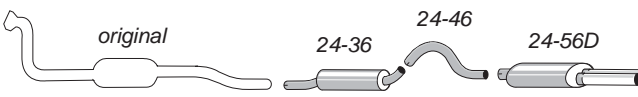

## 24-H6D

Half System - Fits to catalyst



Pipe diameter: 63,5 mm  
Tailpipe: Twin Round 70 mm

Diffuser must be trimmed on 740 models to suit twin tailpipes

**740/760 Turbo Saloon/Estate 1983-88**  
(No catalyst - not multilink models)

24-1    24-2    24-36    24-46    24-56    24-M6

**24-K6**  
Complete Kit - Fits to turbo

Pipe diameter: 63,5 mm  
Tailpipe: Round 80 mm

**850 GLT/GLE 2.0-2.5 126-170bhp Saloon/Estate**  
**S70/V70 2.4 126-170bhp**    92-96  
97-99

Original    20-91    20-31    20-47    20-52    20-M5

*The system is not compatible with the type of interior heater that is fitted under the car, beside the silencer.*

**20-H1<sup>EC</sup>**  
Complete kit fits to catalyst

Pipe diameter: 63,5 mm  
Tailpipe: Round 100 mm

**850 GLT/GLE 2.0-2.5 126-170bhp Saloon/Estate**  
**S70/V70 2.4 126-170bhp**    92-96  
97-99

Original    20-92    20-32    20-47    20-52    20-M5

**20-H2**  
Complete kit fits to catalyst

Pipe diameter: 63,5 mm  
Tailpipe: Round 100 mm

**850 Turbo Saloon/Estate**    94-96  
**S70/V70 Turbo**    97-99  
**C70 Turbo Coupe/Cabriolet**    96-05  
(For all turbo models except diesel)

Original    20-95R    20-35R    20-4R    20-55R    20-M5

*The system is not compatible with the type of interior heater that is fitted under the car, beside the silencer.*

**20-H5R<sup>EC</sup>**  
Complete kit fits to catalyst

Pipe diameter: 63,5 mm  
Tailpipe: Round 100 mm

**850 Turbo Saloon/Estate**    94-96  
**S70/V70 Turbo**    97-99  
**C70 Turbo Coupe/Cabriolet**    96-05  
(For all turbo models except diesel)

Original    20-95R    20-35R    20-4R    20D65R    20D55R    20DM5

*The spoiler must be trimmed for the right side tailpipe.*  
*The system is not compatible with the type of interior heater that is fitted under the car, beside the silencer.*

**20DH5R<sup>EC</sup>**  
Complete kit fits to catalyst

Pipe diameter: 63,5 mm  
Tailpipe: Duplex Round 100 mm

**850 Turbo Saloon/Estate**    94-96  
**S70/V70 Turbo**    97-99  
**C70 Turbo Coupe/Cabriolet**    96-05  
(For all turbo models except diesel)

Original    20-97    20-37    20-47    20-57    20-M5

**20-H7**  
Complete kit fits to catalyst

Pipe diameter: 63,5 mm  
Tailpipe: Round 100 mm

850/V70/S70 AWD Turbo -00

Original

20-38

20-48

20-58

20-68

20-M8

## 20-H8

Complete kit fits to original pipework

Pipe diameter: 70 mm  
Tailpipe: Duplex Oval 90/120 mm

C30 Turbo T5 -09

Original

19-9AR

19-3AR\*

19-4AR

19-5CR

19-MC

\*(Racepipe - 19T3AR)

\*Replaces front silencer 19-3AR

## 19-HCR/TR\*

Complete kit fits to catalyst

\*Resonated or non-resonated option

Pipe diameter: 63,5 mm  
Tailpipe: Duplex Round 100 mm

C30 Turbo T5 2010+ (Face lift)

Original

19-9AR

19-3AR\*

19-4AR

19-5DR

19-MC

\*(Racepipe - 19T3AR)

\*Replaces front silencer 19-3AR

## 19-HDR/TR\*

Complete kit fits to catalyst

\*Resonated or non-resonated option

Pipe diameter: 63,5 mm  
Tailpipe: Duplex Round 100 mm

C70 Turbo T5 06+

Original

19-9AR

19-3AR\*

19-4AR

19-5AR

19-6ER

19-7ER

19-MA

\*(Racepipe - 19T3AR)

\*Replaces front silencer 19-3AR

## 19-HER/TR\*

Complete kit fits to catalyst

\*Resonated or non-resonated option

Pipe diameter: 63,5 mm  
Tailpipe: Duplex Round 100 mm

S40/V40 non-Turbo (Phase I) 1.8/2.0 96-00

Original

19-2

19-3

19-4

19-M

## 19-H<sup>EC</sup>

Complete kit fits to catalyst

Pipe diameter: 63,5 mm  
Tailpipe: 2 x Round 80 mm

S40N/V50 2WD Turbo T5 04+

Original

19-9AR

19-3AR\*

19-4AR

19-5AR

19-6AR

19-7AR

19-MA

\*(Racepipe - 19T3AR)

\*Replaces front silencer 19-3AR

## 19-HAR<sup>EC</sup>/TR\*

Complete kit fits to catalyst

\*non-resonated option (no approval)

Pipe diameter: 63,5 mm  
Tailpipe: Duplex Round 100 mm



S60 2WD 2.4 140-170bhp 01+

Original 2C-30 2C-40 2C-50 2C-M0

**2C-H0**  
Complete kit fits to catalyst

Pipe diameter: 63,5 mm  
Tailpipe: Round 90 mm

S60 2WD Turbo 2.0T/2.4T/2.5T/T5/2.4D/D5 01+

Original 2B-30R\* 2B-40R 2B-50R 2B-M0

\*(Racepipe - 2BT30R)

\*Replaces front silencer 2B-30R

**2B-H0R<sup>EC</sup> /TR\***  
Complete kit fits to catalyst

\*non-resonated option (no approval)

Pipe diameter: 63,5 mm + 2x50,8 mm  
Tailpipe: Round 100 mm

S60 AWD Turbo 2.4T/2.5T 01+

Original 2B-36R\* 2B-46R 2B-50R 2B-M6

\*(Racepipe - 2BT30R)

\*Replaces front silencer 2B-36R

**2B-H3R<sup>EC</sup> /TR\***  
Complete kit fits to catalyst

\*non-resonated option (no approval)

Pipe diameter: 63,5 mm + 2x50,8 mm  
Tailpipe: Round 100 mm

S60/V70N R AWD 03+

Original 2B-36R\* 2B-46R 2B-55R 2B-M0

\*(Racepipe - 2BT30R)

\*Replaces front silencer 2B-36R

**2B-H5R<sup>EC</sup> /TR\***  
Complete kit fits to catalyst

\*non-resonated option (no approval)

Pipe diameter: 63,5 mm + 2x50,8 mm  
Tailpipe: 2 x Round 70 mm - adjustable.

S60/V60 2WD T3/T4/T5/2.0T 2010-18  
\*This exhaust ONLY fits models in accordance with the layout shown on page 49  
Also fits R Design

2D-2AR 2D-3AR 2D-4AR 2D-7A1R 2DD5AR 2D-6A1R 02DDMAR

For models without a cutout for right side tailpipe, the diffuser has to be trimmed/replaced.

**2DDHA1R**  
Complete kit fits to catalyst

Pipe diameter: 76,5 mm + 2x63,5 mm  
Tailpipe: Duplex Round 90 mm

S60/V60 2WD/AWD 2.0T/T3/T4/T5/T6 2010-18  
\*This exhaust ONLY fits models in accordance with the layout shown on page 49  
Also fits R Design

original 2D-4AR 2D-7A9R 2DD5AR 2D-6A9R 02DDMAR

For models without a cutout for right side tailpipe, the diffuser has to be trimmed/replaced.

**2DDBA1R<sup>EC</sup>**  
Back box and connecting pipes

Pipe diameter: 76,5 mm + 2x63,5 mm  
Tailpipe: Duplex Round 90 mm

S60/V60 2WD/AWD D2/D3/D5/DRIVE 2010-18  
Also fits R Design

original

For models without a cutout for right side tailpipe, the diffuser has to be trimmed/replaced.

**2DDBE1R<sup>EC</sup>**  
Back box

Pipe diameter: 76,5 mm + 2x63,5 mm  
Tailpipe: Duplex Round 90 mm

S60/V60 2WD/AWD 2.0T/T3/T4/T5/T6 2010-18  
Also fits R Design

original

2D-4AR

2D-7A9R

2DD5AR

02DDMAR

2D-6A9R

For models without a cutout for right side tailpipe, the diffuser has to be trimmed/replaced.

**2DDBA1R<sup>EC</sup>**  
Back box and connecting pipes

Pipe diameter: 76,5 mm + 2x63,5 mm  
Tailpipe: Duplex Round 90 mm

S60/V60 AWD T6 (not Polestar) 2010-18  
Also fits R Design

original

2D-3CR

2D-4AR

2D-7A1R

2DD5AR

02DDMCR

2D-6A1R

Complete kit fits to catalyst

Pipe diameter: 76,5 mm + 2x63,5 mm  
Tailpipe: Duplex Round 90 mm

**2DDHC1R**  
Complete kit fits to catalyst

Pipe diameter: 76,5 mm + 2x63,5 mm  
Tailpipe: Duplex Round 90 mm

S60/V60 2WD/AWD D2/D3/D5/DRIVE 2010-18  
Also fits R Design

original

2D-7A1R

2DD5ER

02DDMEBR

2D-6A1R

For models without a cutout for right side tailpipe, the diffuser has to be trimmed/replaced.

**2DDBE1R<sup>EC</sup>**  
Back box

Pipe diameter: 76,5 mm + 2x63,5 mm  
Tailpipe: Duplex Round 100 mm

S80 Turbo 2WD 2.0T/2.4T/2.5T/T6 98-06

Original

2B-3AR

2B-40R

2B-5AR

2B-M0

Complete kit fits to catalyst

Pipe diameter: 63,5 mm + 2x50,8 mm  
Tailpipe: Round 90 mm

**2B-HAR<sup>EC</sup>**  
Complete kit fits to catalyst

Pipe diameter: 63,5 mm + 2x50,8 mm  
Tailpipe: Round 90 mm

S80 2.4 140-170bhp 98-06  
S80 2.4TD 131bhp 01-06

Original

2C-30

2C-40

2C-52

2C-M0

Complete kit fits to catalyst

Pipe diameter: 63,5 mm  
Tailpipe: Round 90 mm

**2C-H2**  
Complete kit fits to catalyst

Pipe diameter: 63,5 mm  
Tailpipe: Round 90 mm

S90/V90 D3/D4/D5 2WD/4WD 2017+

For models with chrome trims integrated into the spoiler, the trims must be removed for exhaust to fit. For other models, the OE spoiler must be trimmed.

**2DEDH8DR**

Complete kit fits to downpipe

Pipe diameter: 76,5 mm + 2x63,5 mm  
Tailpipe: Quad Round 90 mm

V40 T4/T5 2WD 5-cyl 2013-15

*Original*

\*(Racepipe - 19T3AR)

\*Replaces front silencer 19-3AR

**19-HJR/TR\***

Complete kit fits to catalyst

\*Resonated or non-resonated option

Pipe diameter: 63,5 mm  
Tailpipe: Duplex Round 100 mm

V40 T2/T3/T4/T5 2WD 4-cyl 2013+

*Original*

\*(Racepipe - 19T3AR)

\*Replaces front silencer 19-3AR

**19-HKR/TR\***

Complete kit fits to catalyst

\*Resonated or non-resonated option

Pipe diameter: 63,5 mm  
Tailpipe: Duplex Round 100 mm

V60 2WD T3/T4/T5 2010-18

*\*This exhaust ONLY fits models in accordance with the layout shown on page 49 Also fits R Design*

Fits models with first exhaust hanger on passenger side of the car.  
For models without sharp bend towards driver's side in the centre of the floor panel.

**2DDHA1R**

Complete kit fits to catalyst

Pipe diameter: 76,5 mm + 2x63,5 mm  
Tailpipe: Duplex Round 90 mm

V70N (P2) 2WD 2.4 140-170bhp 01-07

*Original*

**2C-H1**

Complete kit fits to catalyst

Pipe diameter: 63,5 mm  
Tailpipe: Round 90 mm

V70N (P2) Turbo 2WD 2.0T/2.4T/2.5T/T5/2.4D/2.5D/D5 01-5/04

*Original*

\*(Racepipe - 2BT30R)

\*Replaces front silencer 2B-30R

**2B-H1R<sup>EC</sup>/TR\***

Complete kit fits to catalyst

\*non-resonated option (no approval)

Pipe diameter: 63,5 mm + 2x50,8 mm  
Tailpipe: Round 100 mm



V70N (P2) Turbo 2WD 2.5T/T5/2.4D/D5 6/04-07

*Original* 2B-30R\* 2B-40R 2B-52R 2B-M0

\*(Racepipe - 2BT30R)

\* Replaces front silencer 2B-30R

**2B-H2R<sup>EC</sup> /TR \***

Complete kit fits to catalyst  
\*non-resonated option (no approval)

Pipe diameter: 63,5 mm + 2x50,8 mm  
Tailpipe: Round 100 mm

V70N (P2) AWD Turbo 2.4T/2.5T/D5 01-5/04

*Original* 2B-36R\* 2B-46R 2B-51R 2B-M6

\*(Racepipe - 2BT30R)

\*Replaces front silencer 2B-36R

**2B-H6R<sup>EC</sup> /TR \***

Complete kit fits to catalyst  
\*non-resonated option (no approval)

Pipe diameter: 63,5 mm+ 2x50,8 mm  
Tailpipe: Round 100 mm

V70N (P2) AWD Turbo 2.5T/T5/2.4D/D5 6/04-07

*Original* 2B-36R\* 2B-46R 2B-52R 2B-M6

\*(Racepipe - 2BT30R)

\*Replaces front silencer 2B-36R

**2B-H8R<sup>EC</sup> /TR \***

Complete kit fits to catalyst  
\*non-resonated option (no approval)

Pipe diameter: 63,5 mm+ 2x50,8 mm  
Tailpipe: Round 100 mm

V70N R (P2) 03-07

*Original* 2B-36R\* 2B-46R 2B-55R 2B-M0

\*(Racepipe - 2BT30R)

\*Replaces front silencer 2B-36R

**2B-H5R<sup>EC</sup> /TR \***

Complete kit fits to catalyst  
\*non-resonated option (no approval)

Pipe diameter: 63,5 mm+ 2x50,8 mm  
Tailpipe: 2 x Round 70 mm - adjustable.

V70N (P2) XC AWD/XC70 2.4T/2.5T/D5 01-07

*Original* 2B-36R\* 2B-46R 2B-57R 2B-M6

\*(Racepipe - 2BT30R)

\*Replaces front silencer 2B-36R

**2B-H7R<sup>EC</sup> /TR \***

Complete kit fits to catalyst  
\*non-resonated option (no approval)

Pipe diameter: 63,5 mm+ 2x50,8 mm  
Tailpipe: Round 100 mm

V70/XC70 (P3) AWD T6 07+

*original* 2DDB41R 2DD611R 2DD48R 2DD511R 02DDM4BR 2DTF4R - Silencer replacement kit option

**2DDB41R<sup>EC</sup>**

Back box and connecting pipes

Pipe diameter: 63,5 mm + 2x57 mm  
Tailpipe: Duplex Round 100 mm

**V70 (P3) 2WD 2.0T/T4/T5/2.5FT + Bi-Fuel 07+**  
**Also fits R Design.**

Original 2D-21R 2DD611R  
 2D-31R 2DD41R 02DDM1R  
 2DD511R

Use extension part 2D-90R for 1.6L engines

The tailpipes can be lifted or lowered depending on whether there is a cutout for the tailpipes.

**2DDH11R<sup>EC</sup>**  
 Complete kit fits to catalyst  
 Also fits 'R' Model

Pipe diameter: 63,5 mm + 2x57 mm  
 Tailpipe: Duplex Round 100 mm

**V70/XC70 (P3) 2WD 1.6D/2.0D/2.4D/D3/D4/D5 07+**  
 (for DPF models only). Only fits 2WD models as per layout on page 49. **Also fits R Design.**

Original 2D-25R 2DD651R  
 2D-31R 2DD41R 02DDM5R  
 2DD551R

Use extension part 2D-90R for 1.6L engines

The tailpipes can be lifted or lowered depending on whether there is a cutout for the tailpipes.

**2DDH51R<sup>EC</sup>**  
 Complete kit fits to catalyst  
 Also fits 'R' Model

Pipe diameter: 63,5 mm + 2x57 mm  
 Tailpipe: Duplex Round 100 mm

**V70/XC70 (P3) AWD D4/D5 08+ (for DPF models only)**  
**V70/XC70 (P3) 2WD D3\*/D4\* 08+ (for DPF models only)**  
 \*Only fits 2WD models as per layout on page 49. **Also fits R Design.**

Original 2D-28R 2D-38R 2DD651R  
 2D-48R 02DDM5R  
 2DD551R

Use extension part 2D-90R for 1.6L engines

The tailpipes can be lifted or lowered depending on whether there is a cutout for the tailpipes.

**2DDH81R<sup>EC</sup>**  
 Complete kit fits to catalyst  
 Also fits 'R' Model

If there is only one cutout on the left side of the diffuser then the diffuser has to be trimmed or replaced and hanger kit 2DDFRS used for the right sided tailpipe.

Pipe diameter: 63,5 mm + 2x57 mm  
 Tailpipe: Duplex Round 100 mm

**V90/S90 D3/D4/D5 2WD/4WD 2017+**

2E-28R 2E-38R 2ED58R 2ED78DR  
 2ED48R 02EDM8DR  
 2ED58R 2ED68DR

For models with chrome trims integrated into the spoiler, the trims must be removed for exhaust to fit. For other models, the OE spoiler must be trimmed.

**2DEDH8DR**  
 Complete kit fits to downpipe

Pipe diameter: 76,5 mm + 2x63,5 mm  
 Tailpipe: Quad Round 90 mm

**XC60 AWD T6 08+**  
**Also fits R Design**

original 2D-3CR 2D-4AR 2D-7A1R  
 2DD5AR 02DDMCR  
 2D-6A1R

**2DDHD1R**  
 Complete kit fits to catalyst

Pipe diameter: 76,5 mm + 2x63,5 mm  
 Tailpipe: Duplex Round 90 mm

**XC60 AWD T6 08+**  
**Also fits R Design**

original 2D-4AR 2D-7B9R  
 2DD5AR 02DDMAR  
 2D-6B9R

**2DDBB1R<sup>EC</sup>**  
 Back box and connecting pipes

Pipe diameter: 76,5 mm + 2x63,5 mm  
 Tailpipe: Duplex Round 90 mm

XC60 2WD/AWD D3/D4/D5/2.4D 09-  
Also fits R Design

original

For models without a cutout for right side tailpipe, the diffuser has to be trimmed/replaced.

**2DDBF1R<sup>EC</sup>**  
Back Box

Pipe diameter: 76,5 mm + 2x63,5 mm  
Tailpipe: Duplex Round 100 mm

XC90 2.5T/T6/D5/V8 03+ 2BDM9

Original 2B-36R\* 2BD49R 2BD59DR 2BD69DR

\*(Racepipe - 2BT30R)

\*Replaces from silencer 2B-36R  
The spoiler must be trimmed for the right side tailpipe. The spare wheel must be removed.

**2BDH9DR/TR\***

Complete kit fits to catalyst  
\*Resonated or non-resonated option

Pipe diameter: 63,5 mm+ 2x50,8 mm  
Tailpipe: Quad Round 80 mm

\*Important information for exhaust part numbers:

**2DDHA1R and 2DDBA1R will fit the layout with a green tick.**

\*Important information for exhaust part numbers:

**2DDH51R will fit the layout with a green tick.**

\*Important information for exhaust part numbers:

**2DDH81R will fit the layout with a green tick.**



the exhaust system



# Universal Parts 2023

1.5" to 5" exhaust parts for road, race and rally applications

[www.jetex.co.uk](http://www.jetex.co.uk)

 /jetexexhausts

 #jetexexhaustsuk



**jetex**  
EXHAUSTS | AIR FILTERS | SPORTS CATALYSTS  
SINCE 1986

# Universal Exhaust Parts

Jetex are probably the U.K.'s leading supplier of universal exhaust parts for road, race or rally use. Parts are available with diameters of 1.5" (38 mm) to 5" (127 mm) in either stainless or aluminised/mild steel. Unique silencer fabrication allows 2" boxes to withstand temperatures of up to 600 degrees centigrade (for normal road conditions), while our 2.5", 3" and 3.5" boxes can withstand temperatures of up to 800 degrees centigrade (for higher powered engines and when used for race and rally applications).

Choose from a wide range of pipework, bends, silencer boxes, adaptors and tailpipes to construct an almost endless variety of free-flowing, power enhancing custom exhausts to suit your own unique application. Together with our range of Sports Catalysts, Jetex offer the total solution for road or race conditions.

Our 4 inch and 5 inch exhaust parts can be used for truck exhausts, and are ideal for extreme performance applications such as drag racing.

When building an exhaust system, it is important to purchase parts that give good damping effects and flow characteristics in order to obtain the best performance from the engine.

For competition use, it is necessary to consider noise regulations. Jetex 'straight-through' absorption silencers are well insulated with wire wool around the centre tubing to ensure that the insulation does not burn out and raise noise levels.

When assembling a D.I.Y system, the following should be taken into account:

- 4 cyl. engines for street use - 2-3 silencer boxes; for competition use - 1-2 silencer boxes
- 6 cyl. engines for street use - 3-4 silencer boxes; for competition use - 2-3 silencer boxes

For engines with power output of 150bhp or more it is advisable to construct an exhaust from at least 2.5" parts.

Jetex parts are designed to fit together using slip joints. For example, one end of a 30 degree 2" bend will have a 2" inside diameter, while the other end will have an outside diameter of 2".

Dimensions are outside diameter unless stated otherwise.



## Universal 1.5" (38mm)

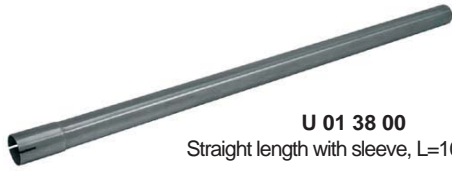

**U 01 38 00**  
Straight length with sleeve, L=1000 mm



**U 01 38 50**  
Straight length with sleeve, L=500 mm



**U 03 38 90**  
Short elbow, 90°  
CLR=42 mm



**U 02 38 30**  
Bend 30°  
CLR=60 mm



**U 02 38 45**  
Bend 45°  
CLR=60 mm



**U 02 38 60**  
Bend 60°  
CLR=60 mm



**U 02 38 90**  
Bend 90°  
CLR=60 mm



**U 02 38 18**  
Bend 180°  
CLR=60 mm

## Universal 1.5" (38mm) Stainless Steel

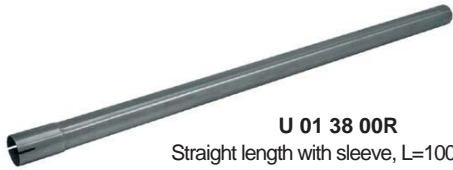

**U 01 38 00R**  
Straight length with sleeve, L=1000 mm



**U 01 38 50R**  
Straight length with sleeve, L=500 mm



**U 03 38 90R**  
Short elbow, 90°  
CLR=42 mm



**U 02 38 30R**  
Bend 30°  
CLR=60 mm



**U 02 38 45R**  
Bend 45°  
CLR=60 mm



**U 02 38 60R**  
Bend 60°  
CLR=60 mm



**U 02 38 90R**  
Bend 90°  
CLR=60 mm



**U 02 38 18R**  
Bend 180°  
CLR=60 mm

## Universal 1.65" (42mm)



**U 01 42 00**  
Straight length with sleeve, L=1000 mm



**U 01 42 50**  
Straight length with sleeve, L=500 mm



**U 02 42 30**  
Bend 30°  
CLR=75 mm



**U 02 42 45**  
Bend 45°  
CLR=75 mm



**U 02 42 60**  
Bend 60°  
CLR=75 mm



**U 02 42 90**  
Bend 90°  
CLR=75 mm



**U 02 42 18**  
Bend 180°  
CLR=75 mm

## Universal 1.65" (42mm) Stainless Steel

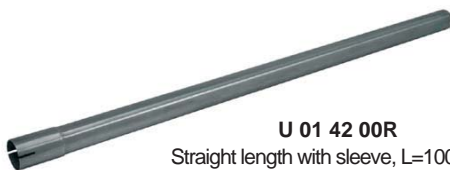

**U 01 42 00R**  
Straight length with sleeve, L=1000 mm



**U 01 42 50R**  
Straight length with sleeve, L=500 mm



**U 02 42 30R**  
Bend 30°  
CLR=75 mm



**U 02 42 45R**  
Bend 45°  
CLR=75 mm



**U 02 42 60R**  
Bend 60°  
CLR=75 mm



**U 02 42 90R**  
Bend 90°  
CLR=75 mm



**U 02 42 18R**  
Bend 180°  
(with sleeve)  
CLR=75 mm



# Universal 1.75" (45mm)

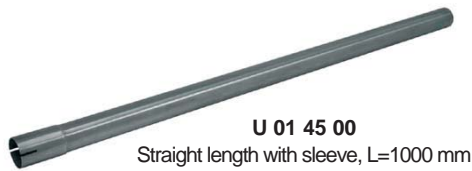

**U 01 45 00**  
Straight length with sleeve, L=1000 mm



**U 06 45 00**  
Double-end sleeve  
I/D 1.75", L=100 mm



**U 03 45 90**  
Short elbow, 90°  
CLR=50 mm



**U 02 45 30**  
Bend 30°  
CLR=100 mm



**U 01 45 50**  
Straight length with sleeve, L=500 mm



**U 07 45 00**  
Stepped sleeve, 45-42-38 mm  
L= 160 mm



**U 03 45 00**  
Flanges with gasket



**U 02 45 45**  
Bend 45°  
CLR=100 mm



**U 05 45 50**  
Flexible straight length, galvanised steel  
L=500 mm, I/D=1.75"



**U 33 45 00**  
Silencer "MEDIUM 45"  
Oval 100/165 mm, L=420 mm (excl. ends)



**U 02 45 18**  
Bend 180°  
CLR=75 mm



**U 02 45 60**  
Bend 60°  
CLR=100 mm



**U 04 45 00**  
Over-axle bend, L=650 mm  
CLR=100 mm



**U 41 45 00**  
Silencer "MIDI 45"  
Round 100 mm, L=420 mm (excl. ends)



**U 40 45 00**  
Silencer "MICRO 45"  
Round 80 mm, L=400 mm (excl. ends)



**U 02 45 90**  
Bend 90°  
CLR=100 mm

# Universal 1.75" (45mm) Stainless Steel



**U 01 45 00R**  
Straight length with sleeve, L=1000 mm



**UFILOK45MM**  
Stainless steel flex-connector.  
Main body, stainless steel.  
End caps, aluminised steel  
L=152.4 mm/6". Fits over a 1.75" pipe.



**U 06 45 00R**  
Double-end sleeve  
I/D 1.75", L=100 mm



**U 03 45 90R**  
Short elbow, 90°  
CLR=50 mm



**U 02 45 30R**  
Bend 30°  
CLR=100 mm



**U 01 45 50R**  
Straight length with sleeve, L=500 mm



**UFILOK45BMM**  
Stainless steel flex-connector.  
Main body, stainless steel.  
End caps, aluminised steel  
L=101.6 mm/4". Fits over a 1.75" pipe.



**U 07 45 00R**  
Stepped sleeve, 45-42-38 mm  
L= 160 mm



**U 02 45 45R**  
Bend 45°  
CLR=100 mm



**U 05 45 50R**  
Flexible straight length  
L=500 mm, I/D=1.75"



**U 25 45 00**  
Rondo 45"  
Round 70 mm, L=260 mm



**U 41 45 00R**  
Silencer "MIDI 45"  
Round 100 mm, L=420 mm (excl. ends)



**U 02 45 60R**  
Bend 60°  
CLR=100 mm



**U 04 45 00R**  
Over-axle bend, L=650 mm  
CLR=100 mm



**U 33 45 00R**  
Silencer "MEDIUM 45"  
Oval 100/165 mm, L=420 mm (excl. ends)



**U 40 45 00R**  
Silencer "MICRO 45"  
Round 76 mm, L=400 mm (excl. ends)



**U 02 45 90R**  
Bend 90°  
CLR=100 mm



**U 02 45 18R**  
Bend 180°  
CLR=75 mm



# Universal 1.89" (48mm)



**U 01 48 00**  
Straight length with sleeve, L=1000 mm



**U 01 48 50**  
Straight length with sleeve, L=500 mm



**U 06 48 00**  
Double-end sleeve  
I/D 48mm, L=100 mm



**U 02 48 30**  
Bend 30°  
CLR=75 mm



**U 02 48 45**  
Bend 45°  
CLR=75 mm



**U 02 48 60**  
Bend 60°  
CLR=75 mm



**U 02 48 90**  
Bend 90°  
CLR=75 mm



**U 02 48 18**  
Bend 180°  
(with sleeve)  
CLR=75 mm

# Universal 1.89" (48mm) Stainless Steel



**U 01 48 00R**  
Straight length with sleeve, L=1000 mm



**U 01 48 50R**  
Straight length with sleeve, L=500 mm



**U 02 48 30R**  
Bend 30°  
CLR=75 mm



**U 02 48 45R**  
Bend 45°  
CLR=75 mm



**U 02 48 60R**  
Bend 60°  
CLR=75 mm



**U 02 48 90R**  
Bend 90°  
CLR=75 mm



**U 02 48 18R**  
Bend 180°  
CLR=75 mm



**UFILOK48MM**  
Stainless steel flex-connector.  
Main body, stainless steel.  
End caps, aluminised steel  
L=152.4mm/6". Fits over a  
48mm pipe.



**UFILOK48BMM**  
Stainless steel flex-connector.  
Main body, stainless steel.  
End caps, aluminised steel  
L=101.6 mm/4". Fits over a  
48mm pipe.

# Universal 2" (50.8mm)

January 2023 [Issue 37]



**U 01 51 00**  
Straight length with sleeve, L=1000 mm



**U 01 51 50**  
Straight length with sleeve, L=500 mm



**U 05 51 50**  
Flexible straight length, galvanised steel  
L=500 mm, I/D 2"



**U 02 51 30**  
Bend 30°  
CLR=100 mm



**U 04 51 17**  
Over-axle bend, L=660 mm  
CLR=100 mm



**U 06 51 20**  
Double-end sleeve  
I/D 2", L=100 mm



**U 03 51 00**  
Flanges with gasket



**U 02 51 45**  
Bend 45°  
CLR=100 mm



**U 02 51 18**  
Bend 180°  
CLR=85 mm



**U 07 51 15**  
Stepped sleeve, 51-48-41 mm



**U 03 51 90**  
Short elbow, 90°  
CLR=50 mm



**U 02 51 60**  
Bend 60°  
CLR=100 mm



**U 93 51 30**  
**Decibel insert**  
Should be placed inside piping in order to obtain  
an effective sound damping (note that this also leads to  
higher backpressure), L=283 mm



**U 05 51 00**  
**Compensator**  
Should be used to prevent pipe fracture between  
the manifold and exhaust system, L=195 mm



**U 02 51 90**  
Bend 90°  
CLR=100 mm



**U 40 51 20**  
Silencer "MICRO 51"  
Round 80 mm, L=400 mm (excl. ends)



**U 32 51 00**  
Silencer "BIG 51"  
Oval 115/185 mm, L=420 mm (excl. ends)



**U 33 51 39**  
Silencer "MEDIUM 51"  
Oval 100/165 mm  
L=420 mm (excl. ends)



**U 41 51 29**  
Silencer "MIDI 51"  
Rund/round 100 mm, L=420 mm (excl. ends)



**U 35 51 24**  
Silencer "SMALL"  
Oval 100/165 mm  
L=320 mm (excl. ends)

# Universal 2" (50.8mm) Stainless Steel



January 2023 [Issue 37]



**U 01 51 00R**  
Straight length with sleeve, L=1000 mm



**U 01 51 50R**  
Straight length with sleeve, L=500 mm



**U 25 51 00**  
Tailpipe "RONDO 51"  
Round 70 mm, L=274 mm



**U 02 51 30R**  
Bend 30°  
CLR=100 mm



**U 05 51 50R**  
Flexible straight length  
L=500 mm, I/D 2"



**U 06 51 00R**  
Double-end sleeve  
I/D 2", L=100 mm



**U 25 51 10**  
Tailpipe "RONDO XL 51"  
Round 100 mm, L=276 mm



**U 02 51 45R**  
Bend 45°  
CLR=100 mm



**UFILOK515MM**  
Stainless steel flex-connector.  
Main body, stainless steel.  
End caps, aluminised steel  
L=152.4 mm/6". Fits over a 2" pipe.



**U 07 51 00R**  
Stepped sleeve  
51-48-41 mm  
L= 160 mm



**U 23 51 00**  
Tailpipe "ELLIPS 51"  
Oval 70/90 mm, L=274 mm



**U 02 51 60R**  
Bend 60°  
CLR=100 mm



**UFILOK515BMM**  
Stainless steel flex-connector.  
Main body, stainless steel.  
End caps, aluminised steel  
L=101.6 mm/4". Fits over a 2" pipe.



**U 40 51 00R**  
Silencer "MICRO 51"  
Round 76 mm, L=400 mm (excl. ends)



**U 02 51 90R**  
Bend 90°  
CLR=100 mm



**U 02 51 18R**  
Bend 180°  
CLR=85 mm



**U 04 51 00R**  
Over-axle bend, 660 mm  
CLR=100 mm



**U 41 51 00R**  
Silencer "MIDI 51"  
Round 100 mm, L=420 mm (excl. ends)



**U 34 51 DR**  
Silencer "DUO 51"  
Pipe dimensions: 4 x 50.8 mm  
Oval 115/185 mm, L=315 mm (excl. ends)



**U 03 51 90R**  
Short elbow, 90°  
CLR=100 mm



**U 33 51 00R**  
Silencer "MEDIUM 51"  
Oval 100/165 mm, L=420 mm (excl. ends)



**U 35 51 00R**  
Silencer "SMALL"  
Oval 100/165 mm L=320 mm (excl. ends)



**U 32 51 00R**  
Silencer "BIG 51"  
Oval 115/185 mm, L=420 mm (excl. ends)

# Universal 2.13" (54mm) Stainless Steel

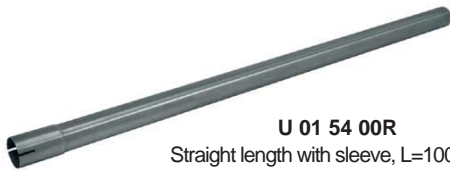

**U 01 54 00R**  
Straight length with sleeve, L=1000 mm



**U 01 54 50R**  
Straight length with sleeve, L=500 mm



**U 02 54 30R**  
Bend 30°  
CLR=110 mm



**U 02 54 45R**  
Bend 45°  
CLR=110 mm



**U 02 54 60R**  
Bend 60°  
CLR=110 mm



**U 02 54 90R**  
Bend 90°  
CLR=110 mm

# Universal 2.25" (57mm) Stainless Steel



**U 01 57 00R**  
Straight length with sleeve, L=1000 mm



**U 03 57 90R**  
Short elbow, 90°  
CLR= 58 mm



**UFILOK57BMM**  
Stainless steel flex-connector.  
Main body, stainless steel.  
End caps, aluminised steel  
L=101.6 mm/4". Fits over a 57 mm pipe.



**U 02 57 30R**  
Bend 30°  
CLR=110 mm



**U 02 57 45R**  
Bend 45°  
CLR=110 mm



**U 02 57 60R**  
Bend 60°  
CLR=110 mm



**U 02 57 90R**  
Bend 90°  
CLR=110 mm

# Universal 2.4" (60.3mm) Stainless Steel



**U 01 60 00R**  
Straight length with sleeve, L=1000 mm



**U 02 60 18R**  
Bend 180°  
CLR=100 mm



**U 02 60 30R**  
Bend 30°  
CLR=100 mm



**U 02 60 45R**  
Bend 45°  
CLR=100 mm



**U 02 60 60R**  
Bend 60°  
CLR=100 mm



**U 02 60 90R**  
Bend 90°  
CLR=100 mm



# Universal 2.5" (63.5mm)

January 2023 [Issue 37]



**U 01 63 00**  
Straight length with sleeve,  
L=1000 mm



**U 01 63 50**  
Straight length with sleeve,  
L=500 mm



**U 07 63 20**  
Stepped sleeve  
63.5-57-50.8 mm, L=190 mm



**U 06 63 20**  
Double-end sleeve  
I/D 2.5", L=150 mm



**U 02 63 30**  
Bend 30°  
CLR=130 mm



**U 04 63 21**  
Over-axle bend, L=900 mm  
CLR=100 mm



**U 05 63 50**  
Flexible straight length,  
galvanised steel,  
L=500 mm, I/D 2.5"



**U 06 63 15**  
Adaptor Pipe  
I/D 2.5" to 2.5" O/D  
L=148 mm



**U 02 63 45**  
Bend 45°  
CLR=130 mm



**U 02 63 60**  
Bend 60°  
CLR=130 mm



**U 93 63 30**  
**Decibel insert**  
Should be placed inside piping in order to  
obtain an effective sound damping  
(note that this also leads to higher backpressure), L=275 mm



**U 02 63 18**  
Bend 180°  
CLR=100 mm



**U 03 63 00**  
Flanges with gasket



**U 02 63 90**  
Bend 90°  
CLR=130 mm



**U 05 63 00**  
**Compensator**  
Should be used to prevent pipe fracture between  
the manifold and exhaust system, L=185 mm



**U 03 63 90**  
Short elbow, 90°  
CLR=60 mm



**U 45 63 00**  
Silencer "HANDY"  
Round 125 mm  
L=250 mm (excl. ends)



**U 31 63 35**  
Silencer "SUPER"  
Oval 115/185 mm, L=320 mm (excl. ends)



**U 44 63 00**  
Silencer "TUBEX"  
Round 100 mm L=625 mm (excl. ends)



**U 33 63 00**  
Silencer "HEAVY"  
Oval 140/220 mm  
L=500 mm (excl. ends)



**U 34 63 51**  
Silencer "SPLIT 63"  
Pipe dimensions: 63.5 mm + 2x50.8 mm  
Oval 115/185 mm, L=320 mm (excl. ends)



**U 43 63 37**  
Silencer "SLIM"  
Round 125 mm, L=420 mm (excl. ends)



**U 32 63 40**  
Silencer "BIG 63"  
Oval 115/185 mm, L=420 mm (excl. ends)

# Universal 2.5" (63.5mm) Stainless Steel



January 2023 [Issue 37]



**U 02 63 30R**  
Bend 30°  
CLR=130 mm



**U 02 63 45R**  
Bend 45°  
CLR=130 mm



**U 02 63 60R**  
Bend 60°  
CLR=130 mm



**U 02 63 90R**  
Bend 90°  
CLR=130 mm



**U 02 63 18R**  
Bend 180°  
CLR=100 mm



**U 01 63 00R**  
Straight length with sleeve,  
L=1000 mm



**U 01 63 50R**  
Straight length with sleeve,  
L=500 mm



**U 05 63 50R**  
Flexible straight length  
L=500 mm, I/D 2.5"



**U 07 63 00R**  
Stepped sleeve  
63.5-57-50.8 mm, L=190 mm



**UFILOK635MM**  
Stainless steel flex-connector.  
Main body, stainless steel.  
End caps, aluminised steel  
L=152.4 mm/6". Fits over a 2.5" pipe.



**U 03 63 01R**  
Three-bolt flange assembly  
Both ends 2.5" O/D, L=190 mm



**U 03 63 90R**  
Short elbow, 90°, CLR=60 mm



**UFILOK635BMM**  
Stainless steel flex-connector.  
Main body, stainless steel.  
End caps, aluminised steel  
L=101.6 mm/4".  
Fits over a 2.5" pipe.



**U 04 63 00R**  
Over-axle bend, L=900 mm  
CLR=130 mm



**AA635483**  
Adaptor sleeve  
O/D 63.5 mm to  
I/D 48 mm  
L=105 mm



**AA635511**  
Adaptor sleeve  
O/D 63.5 mm to  
I/D 50.8 mm  
L=105 mm



**AA635553**  
Adaptor sleeve  
O/D 63.5 mm to  
I/D 55 mm  
L=105 mm



**U 06 63 00R**  
Double-end sleeve  
I/D 2.5", L=120 mm



**U 43 63 00R**  
Silencer "SLIM"  
Round 125 mm, L=420 mm (excl. ends)



**U 31 63 00R**  
Silencer "SUPER"  
Oval 115/185 mm, L=320 mm (excl. ends)



**U 45 63 00R**  
Silencer "HANDY"  
Round 125 mm  
L=250 mm (excl. ends)



**U 32 63 00R**  
Silencer "BIG 63"  
Oval 115/185 mm, L=420 mm (excl. ends)



**U 33 63 00R**  
Silencer "HEAVY"  
Oval 140/220 mm  
L=500 mm (excl. ends)



**U 44 63 00R**  
Silencer "TUBEX"  
Round 100 mm, L=625 mm (excl. ends)

# Universal 2.5" (63.5mm) Stainless Steel



January 2023 [Issue 37]



**U 34 63 51R**  
 Silencer "SPLIT 63"  
 Pipe dimensions: 63.5 mm + 2 x 50.8 mm  
 Oval 115/185 mm, L=320 mm (excl. ends)



**U 34 63 DR**  
 Silencer "DUO 63"  
 Pipe dimensions: 4 x 63.5 mm  
 Oval 115/185 mm, L=315 mm (excl. ends)



**U 11 DJ DD**  
 Silencer "JETEX"  
 Inlet pipe: 63.5 mm  
 Oval silencer 140/220, L=420 mm  
 Tailpipes Twin Round 80 mm, L=190 mm (excl. ends)  
 Tailpipe width 165 mm  
 Hanger point (A) 160 mm from end of taipipes



**U 32 63 51R**  
 Silencer "DUPLEX 63-51"  
 Pipe dimensions: 63.5 mm + 2x50.8 mm  
 Oval 140/220 mm, L=500 mm (excl. ends)



**U 23 63 0L**  
 Tailpipe "ELLIPS 63 Left"  
 Oval 90/120, L= 220 mm

**U 23 63 0R**  
 Tailpipe "ELLIPS 63 Right"  
 Oval 90/120, L=220 mm



**U 23 63 20**  
 Tailpipe "SUPERIOR 63"  
 Oval 90/140 mm, L= 255 mm



**U 26 63 00**  
 Tailpipe "BOLD 63"  
 Flat oval 85/150 mm, L= 245 mm



**U 23 63 10**  
 Tailpipe "ELLIPS XL 63"  
 Oval 90/120 mm, L= 250 mm



**U 25 63 10**  
 Tailpipe "RONDO XL 63"  
 Round 100 mm, L= 265 mm



**U 25 63 00**  
 Tailpipe "RONDO 63"  
 Round 80 mm, L= 275 mm



**U 23 63 00**  
 Tailpipe "ELLIPS 63"  
 Oval 70/90 mm, L= 270 mm



**U 24 63 00**  
 Tailpipe "QUATTRO 63"  
 Square 70/90 mm, L= 270 mm

# Universal 2.75" (70mm) Stainless Steel



January 2023 [Issue 37]

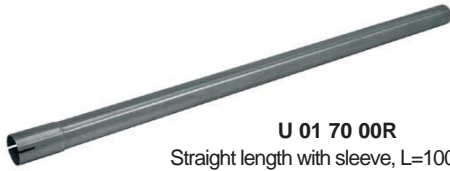

**U 01 70 00R**  
Straight length with sleeve, L=1000 mm



**U 01 70 50R**  
Straight length with sleeve, L=500 mm



**U 02 70 30R**  
Bend 30°  
CLR=110 mm



**U 02 70 45R**  
Bend 45°  
CLR=110 mm



**U 02 70 60R**  
Bend 60°  
CLR=110 mm



**U 02 70 90R**  
Bend 90°  
CLR=110 mm



**UFILOK71MM**  
Stainless steel flex-connector.  
Main body, stainless steel.  
End caps, stainless steel  
L=152.4 mm. Fits over a 2.75" pipe.



**U 03 70 90R**  
Short elbow, 90°  
CLR=62 mm



# Universal 3" (76.5mm)

January 2023 [Issue 37]



**U 01 76 00**  
Straight length with sleeve,  
L=1000 mm



**U 01 76 50**  
Straight length with sleeve,  
L=500 mm



**U 05 76 50**  
Flexible pipe,  
galvanised steel,  
L=500 mm, I/D 3"



**U 02 76 30**  
Bend 30°  
CLR=160 mm



**U 02 76 45**  
Bend 45°  
CLR=160 mm



**U 02 76 60**  
Bend 60°  
CLR=160 mm



**U 02 76 90**  
Bend 90°  
CLR=160 mm



**U 04 76 00**  
Over-axle bend, L=890 mm  
CLR=160 mm



**U 03 76 90**  
Short elbow, 90°  
CLR=60 mm



**U 07 76 00**  
Stepped sleeve  
76-67-64 mm, L=195 mm



**U 02 76 18**  
Bend 180°  
CLR=120 mm



**U 93 76 30**  
**Decibel insert.**  
Should be placed inside piping of at least 300 mm in  
order to obtain an effective sound damping (note that this also  
leads to higher backpressure), L=280 mm



**U 03 76 00**  
Flange with gasket



**U 05 76 00**  
**Compensator**  
Should be used to prevent pipe fracture between  
the manifold and exhaust system, L=190 mm  
Stainless-Chromium steel



**U 45 76 00**  
Silencer "TURBONETT"  
Round 125 mm  
L=250 mm (excl. ends)



**U 30 76 00**  
Silencer "TURBOTIGHT"  
Oval 140/220 mm  
L=250 mm (excl. ends)



**U 06 76 20**  
Double-end sleeve  
I/D 3", L=190 mm



**U 32 76 00**  
Silencer "TURBO"  
Oval 140/220 mm, L=500 mm (excl. ends)



**U 44 76 00**  
Silencer "TURBEX"  
Round 125 mm L=625 mm (excl. ends)



**U 33 76 00**  
Silencer "TURBOLIGHT"  
Oval 140/220 mm  
L=420 mm (excl. ends)



**U 34 76 63**  
Silencer "SPLIT 76"  
Pipe dimensions: 76 mm + 2 x 63.5 mm  
Oval 140/220 mm, L=320 mm (excl. ends)

# Universal 3" (76.5mm) Stainless Steel



January 2023 [Issue 37]



**U 01 76 00R**  
Straight length with sleeve,  
L=1000 mm



**U 01 76 50R**  
Straight length with sleeve,  
L=500 mm



**U 05 76 50R**  
Flexible straight length  
L=500 mm. I/D 3"



**U 02 76 30R**  
Bend 30°  
CLR=160 mm



**U 04 76 00R**  
Over-axle bend, L=890 mm



**U 03 76 90R**  
Short elbow, 90°  
CLR=60 mm



**U 02 76 45R**  
Bend 45°  
CLR=160 mm



**UFILOK765BMM**  
Stainless steel flex-connector.  
Main body, stainless steel.  
End caps, stainless steel  
L=101.6 mm/4".  
Fits over a 2.5" pipe.



**U 07 76 00R**  
Stepped sleeve  
76-67-64 mm, L=195 mm



**U 03 76 01R**  
Three-bolt flange assembly  
Both ends 3" O/D, L=190 mm



**U 02 76 60R**  
Bend 60°  
CLR=160 mm



**U 06 76 00R**  
Double-end sleeve,  
L=150 mm I/D 3"



**U 02 76 90R**  
Bend 90°  
CLR=160 mm



**UFILOK765MM**  
Stainless steel flex-connector.  
Main body, stainless steel.  
End caps, stainless steel  
L=152.4 mm/6".  
Fits over a 2.5" pipe.



**AA761638**  
Adaptor sleeve  
O/D 76.5 mm to  
I/D 63.5 mm  
L=115 mm



**U 34 76 63R**  
Silencer "DUO 76"  
Pipe dimensions: 4 x 76 mm  
Oval 140/220 mm, L=315 mm (excl. ends)



**U 02 76 18R**  
Bend 180°  
CLR=120 mm



**U 32 76 63R**  
Silencer "DUPLEX 76-63"  
Pipe dimensions: 76 mm + 2 x 63.5 mm  
Oval 140/220 mm, L=500 mm (excl. ends)



**U 34 76 63R**  
Silencer "SPLIT 76"  
Pipe dimensions: 76 mm + 2 x 63.5 mm  
Oval 140/220 mm, L=320 mm (excl. ends)



**U 45 76 00R**  
Silencer "TURBONETT"  
Round 125 mm L=250 mm (excl. ends)



**U 30 76 00R**  
Silencer "TURBOTIGHT"  
Oval 140/220 mm  
L=250 mm (excl. ends)



**U 44 76 00R**  
Silencer "TURBEX"  
Round 125 mm L=625 mm (excl. ends)



**U 33 76 00R**  
Silencer "TURBOLIGHT"  
Oval 140/220 mm  
L=420 mm (excl. ends)



**U 32 76 00R**  
Silencer "TURBO"  
Oval 140/220 mm,  
L=500 mm (excl. ends)



# Universal 3" (76.5mm) Stainless Steel

January 2023 [Issue 37]



**U 25 76 00**  
Tailpipe "RONDO 76"  
Round 100 mm, L=245 mm



**U 25 76 10**  
Tailpipe "RONDO XL 76"  
Round 114 mm, L=255 mm



**U 26 76 00**  
Tailpipe "BOLD 76"  
Flat oval 85/150 mm, L=240 mm



**U 23 76 00**  
Tailpipe "ELLIPS 76"  
Oval 90/120 mm, L=265 mm



**U 23 76 20**  
Tailpipe "SUPERIOR 76"  
Oval 90/140 mm, L=255 mm



# Universal 3.5" (89.5mm)



**U 02 89 30**  
Bend 30°  
CLR=160 mm



**U 02 89 45**  
Bend 45°  
CLR=160 mm



**U 02 89 60**  
Bend 60°  
CLR=160 mm



**U 02 89 90**  
Bend 90°  
CLR=160 mm



**U 01 89 00**  
Straight length with sleeve,  
L=1000 mm



**U 01 89 50**  
Straight length with sleeve,  
L=500 mm



**U 07 89 00**  
Stepped sleeve  
89-80-76 mm, L=195 mm



**U 03 89 90**  
Short elbow, 90°  
CLR=75 mm



**U 05 89 50**  
Flexible length,  
galvanised steel,  
L=500 mm. I/D 3.5"



**U 06 89 00**  
Double-end sleeve  
I/D 3.5", L=190 mm



**U 32 89 00**  
Silencer "GRAND"  
Oval 140/220 mm  
L=500 mm (excl. ends)



**U 30 89 00**  
Silencer "GRANDOTIGHT"  
Oval 140/220 mm  
L=250 mm (excl. ends)



**U 45 89 00**  
Silencer "GRANDONETT"  
Round 140 mm  
L=250 mm (excl. ends)

# Universal 3.5" (89.5mm) Stainless Steel



**U 02 89 30R**  
Bend 30°  
CLR=160 mm



**U 02 89 45R**  
Bend 45°  
CLR=160 mm



**U 02 89 60R**  
Bend 60°  
CLR=160 mm



**U 02 89 90R**  
Bend 90°  
CLR=160 mm



**U 01 89 00R**  
Straight length with sleeve,  
L=1000 mm



**U 01 89 50R**  
Straight length with sleeve,  
L=500 mm



**U 05 89 50R**  
Flexible straight length  
L=500 mm. I/D 3.5"



**U 30 89 00R**  
Silencer "GRANDOTIGHT"  
Oval 140/220 mm  
L=250 mm (excl. ends)



**UFILOK89S**  
Stainless steel flex-connector.  
Main body, stainless steel.  
End caps, aluminised steel  
L=101.6 mm/4".  
Fits over a 3.5" pipe.



**U 03 89 90R**  
Short elbow, 90°  
CLR=75 mm



**U 07 89 00R**  
Stepped sleeve  
89-79-76 mm, L=195 mm



**U 06 89 00R**  
Double-end sleeve  
I/D 3.5", L=190 mm



**U 45 89 00R**  
Silencer "GRANDONETT"  
Round 140 mm  
L=250 mm (excl. ends)



**U 25 89 10**  
Tailpipe "RONDO XL 89"  
Round 114 mm, L=265 mm



**U 32 89 00R**  
Silencer "GRAND"  
Oval 140/220 mm  
L=500 mm (excl. ends)



# Universal 4" (101.6mm)



**U 02 02 30**  
Bend 30°  
CLR=220 mm



**U 03 02 00**  
Short elbow, 90°  
CLR=75 mm



**U 01 02 00**  
Straight length with sleeve  
L=1000 mm



**U 07 07 26**  
Stepped sleeve  
101.6-76 mm, L=200 mm



**U 02 02 45**  
Bend 45°  
CLR=220 mm



**U 07 02 00**  
Stepped sleeve  
101.6-89 mm, L=200 mm



**U 43 02 00**  
Silencer "GRANDONETXL"  
Round 300 mm  
L=480 mm (excl. ends)



**U 02 02 60**  
Bend 60°  
CLR=220 mm



**U 06 02 00**  
Double-end sleeve  
I/D 4", L=220 mm



**U 44 02 00**  
Silencer "TURBEX-XL"  
Round 200 mm  
L=830 mm (excl. ends)



**U 02 02 90**  
Bend 90°  
CLR=220 mm

# Universal 4" (101.6mm) Stainless Steel



**U 02 02 30R**  
Bend 30°  
CLR=160 mm



**U 07 02 00R**  
Stepped sleeve  
101.6-89 mm, L=200 mm



**U 01 02 00R**  
Straight length with sleeve,  
L=1000 mm



**UFILOK1016203MM**  
Stainless steel flex-connector.  
Main body, stainless steel.  
End caps, stainless steel  
L=203 mm/8".  
Fits over a 4" pipe.



**U 02 02 45R**  
Bend 45°  
CLR=160 mm



**U 06 02 00R**  
Double-end sleeve  
I/D 4", L=220 mm



**U 43 02 00R**  
Silencer "GRANDONETXL"  
Round 300 mm  
L=480 mm (excl. ends)



**U 02 02 60R**  
Bend 60°  
CLR=160 mm



**UFILOK1016MM**  
Stainless steel flex-connector.  
Main body, stainless steel.  
End caps, stainless steel  
L=101.6 mm/4".  
Fits over a 4" pipe.



**U 02 02 90R**  
Bend 90°  
CLR=160 mm



**U 44 02 00R**  
Silencer "TURBEX-XL"  
Round 200 mm  
L=830 mm (excl. ends)



**U 03 02 00R**  
Short elbow, 90°  
CLR=75 mm

# Universal 5" (127mm)



**U 02 27 30**  
Bend 30°  
CLR=285 mm



**U 02 27 45**  
Bend 45°  
CLR=285 mm



**U 02 27 60**  
Bend 60°  
CLR=285 mm



**U 02 27 90**  
Bend 90°  
CLR=285 mm



**U 03 27 90**  
Short elbow, 90°  
CLR=100 mm



**U 07 27 00**  
Stepped sleeve  
127-101.6 mm, L=270 mm



**U 06 27 00**  
Double-end sleeve  
I/D 5", L=260 mm



**U 01 27 00**  
Straight length with sleeve,  
L=1000 mm



**U 43 27 00**  
Silencer "GRANDONETTXL"  
Round 300 mm  
L=480 mm (excl. ends)



**U 44 27 00**  
Silencer "TURBEX-XXL"  
Round 200 mm  
L=830 mm (excl. ends)

# Universal 5" (127mm) Stainless Steel



**U 02 27 30R**  
Bend 30°  
CLR=285 mm



**U 02 27 45R**  
Bend 45°  
CLR=285 mm



**U 02 27 60R**  
Bend 60°  
CLR=285 mm



**U 02 27 90R**  
Bend 90°  
CLR=285 mm



**U 03 27 90R**  
Short elbow, 90°  
CLR=100 mm



**U 07 27 00R**  
Stepped sleeve  
127-101.6 mm, L=195 mm



**U 06 27 00R**  
Double-end sleeve  
I/D 3 1/2", L=190 mm



**U 01 27 00R**  
Straight length with sleeve,  
L=1000 mm



**U 43 27 00R**  
Silencer "GRANDONETTXL"  
Round 300 mm  
L=480 mm (excl. ends)



**U 44 27 00R**  
Silencer "TURBEX-XXL"  
Round 200 mm  
L=830 mm (excl. ends)

# Universal Fittings

January 2023 [Issue 37]

## Fittings



**U 82 62 50**  
Rubber



**U 81 23 08**  
Rubber cushion M8



**U 84 70 25**  
Hanging strap



**U 83 90 45**  
Fixing bracket



**U 83 60 25**  
Bracket



**U 83 15 03**  
Bracket

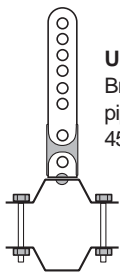

**U 72 45 65**  
Bracket for pipes from 45-65 mm



## Spacers



Should be used to reduce pipework diameter, e.g. AP63-60 will fit into the female end of a 63.5mm pipe and then over a 60mm pipe.

Part No.	O/D	I/D
UA45-40	45	40
UA45-42	45	42
UA51-45	50.8	45.5-45
UA51-48	50.8	48
UA51-50	50.8	50
UA55-50	55	50
UA55-51	55	51
UA55-52	55	52
UA55-54	55	54
UA57-51	57	50.8
UA57-55	57	55
UA60-55	60	55
UA63-57	63.5	57
UA63-60	63.5	60
UA65-60	65	60
UA70-65	70	65

## Lambda Boss (M18x1.5)

U 69 00 10  
U 69 00 10R



## Lambda Plugs (M18x1.5)

U 69 02 00 U 69 02 01

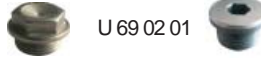

## Hanger Tube 12mm x 1m

Part No.  
M 11 20 15  
M 11 20 15R



## Hanger Bar 10mm x 1m

Part No.  
M 3R S0 10R\*

\* stainless steel only



## Galvanized U Clamps

Part No.	Fits Pipe Dia.
U 70 42 10	42 mm
U 70 45 10	45 mm
U 70 48 10	48 mm
U 70 52 10	52 mm
U 70 54 10	54 mm
U 70 58 10	58 mm
U 70 60 10	60 mm
U 70 64 10	64 mm
U 70 67 10	67 mm
U 70 73 10	73 mm
U 70 80 10	80 mm
U 70 83 10	83 mm
U 70 92 10	92 mm



## Stainless Ring Clamps

Part No.	Fits Pipe Dia.
UBK048R	48 mm
UBK054R	54 mm
UBK057R	57 mm
UBK060R	60 mm
UBK063R	63 mm
UBK067R	67 mm
UBK073R	73 mm
UBK079R	79 mm
UBK092R	92 mm
UBK105R	105 mm
UBK130R	130 mm

## T-Pieces

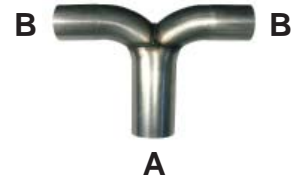

Part No.	A	B
U 91 63 51	63.5	50.8
U 91 63 63	63.5	63.5
U 91 76 63	76	63.5

Stainless Steel	A	B
U 91 63 51R	63.5	50.8
U 91 63 63R	63.5	63.5
U 91 76 63R	76	63.5
U 91 76 76R	76	76
U 91 89 76R	89	76

## Y-Pieces



Part No.	A	B
U 90 51 42	50.8	41.5
U 90 51 45/R	50.8	44.5
U 90 51 51/R	50.8	50.8
U 90 57 45	57	44.5
U 90 57 48	57	48
U 90 63 48	63.5	48
U 90 63 51/R	63.5	50.8
U 90 63 63/R	63.5	63.5
U 90 76 63/R	76	63.5
U 90 76 76R*	76	76
U 90 89 76R*	89	76
U 90 02 89R*	101.6	89

\* stainless only

## X-Pieces



Stainless Steel	A
U 90 51 XR	50.8
U 90 63 XR	63.5
U 90 76 XR	76



## Galvanized Ring Clamps

Part No.	Fits Pipe Dia.
U 71 48 10	48 mm
U 71 54 10	54 mm
U 71 67 10	67 mm



# Technical Pages

January 2023 [Issue 37]

The following pages provide parts dimensions for pipework, silencers and tailpipes within the Jetex Universal Parts range. 'R' denotes stainless steel option. Otherwise parts are mild or aluminised steel.

## Straight Lengths (1.5" to 5"):

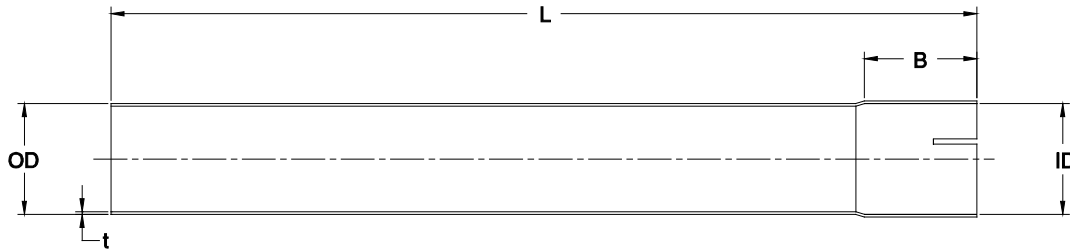

Part No.	Description	O/D	I/D	L	B	t
U013800/R	Pipe with sleeve 1m	38.0	38.3	990	65	1.5
U013850/R	Pipe with sleeve 0.5m	38.0	38.3	490	65	1.5
U014200/R	Pipe with sleeve 1m	42.0	42.3	990	65	1.5
U014250/R	Pipe with sleeve 0.5m	42.0	42.3	490	65	1.5
U014500/R	Pipe with sleeve 1m	44.5	44.8	990	65	1.5
U014550/R	Pipe with sleeve 0.5m	44.5	44.8	490	65	1.5
U014800/R	Pipe with sleeve 1m	48.0	48.3	990	65	1.5
U014850/R	Pipe with sleeve 0.5m	48.0	48.3	490	65	1.5
U015100/R	Pipe with sleeve 1m	50.8	51.1	990	65	1.5
U015150/R	Pipe with sleeve 0.5m	50.8	51.1	490	65	1.5
U015400R	Pipe with sleeve 1m	54.0	54.3	990	65	1.5
U015450R	Pipe with sleeve 0.5m	54.0	54.3	490	65	1.5
U015700R*	Pipe with sleeve 1m	57.0	57.3	990	65	1.5
U016000R*	Pipe with sleeve 1m	60.3	60.5	990	65	1.5
U016300/R	Pipe with sleeve 1m	63.5	63.8	990	65	1.5
U016350/R	Pipe with sleeve 0.5m	63.5	63.8	490	65	1.5
U017000R*	Pipe with sleeve 1m	70.0	70.3	990	65	1.5
U017050R*	Pipe with sleeve 0.5m	70.0	70.3	490	65	1.5
U017600/R	Pipe with sleeve 1m	76.1	76.4	990	75	1.5
U017650/R	Pipe with sleeve 0.5m	76.1	76.4	490	75	1.5
U018900/R	Pipe with sleeve 1m	88.9	89.3	990	75	1.5
U018950/R	Pipe with sleeve 0.5m	88.9	89.3	490	75	1.5
U010200/R	Pipe with sleeve 1m	101.6	102.1	990	90	1.5
U012700/R	Pipe with sleeve 1m	127.0	127.5	990	110	2.0
<i>Tolerance</i>		$\pm 0.1\text{mm}$	$\pm 0.2\text{mm}$	$\pm 5\text{mm}$	$\pm 5\text{mm}$	$\pm 0.1\text{mm}$

## Bends (30-90 Degree) (1.5" to 5"):

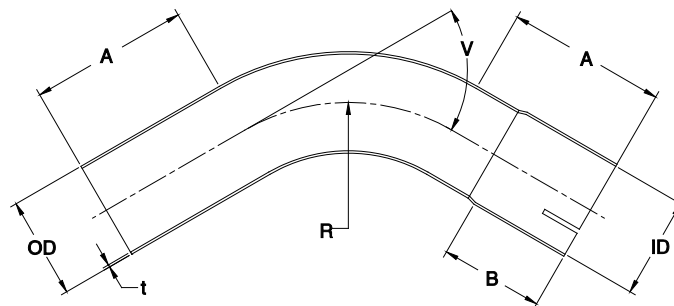

Part No.	Description	O/D	I/D	A	B	R	V	t
U023830/R	Bend with sleeve, 30°	38.0	38.3	75	65	60	30	1.5
U023845/R	Bend with sleeve, 45°	38.0	38.3	75	65	60	45	1.5
U023860/R	Bend with sleeve, 60°	38.0	38.3	75	65	60	60	1.5
U023890/R	Bend with sleeve, 90°	38.0	38.3	75	65	60	90	1.5
U024230/R	Bend with sleeve, 30°	42.0	42.3	84	65	75	30	1.5
U024245/R	Bend with sleeve, 45°	42.0	42.3	84	65	75	45	1.5
U024260/R	Bend with sleeve, 60°	42.0	42.3	84	65	75	60	1.5
<i>Tolerance</i>		$\pm 0.1\text{mm}$	$\pm 0.2\text{mm}$	$\pm 5\text{mm}$	$\pm 5\text{mm}$	$\pm 2\text{mm}$	$\pm 2^\circ$	$\pm 0.1\text{mm}$



**Bends (30-90 Degree) (1.5" to 5") cont...**

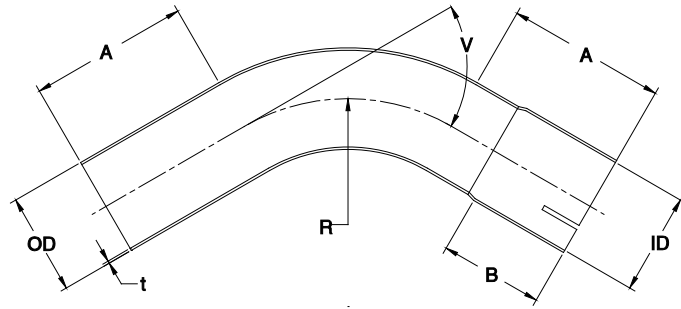

Part No.	Description	O/D	I/D	A	B	R	V	t
U024290/R	Bend with sleeve, 90°	42.0	42.3	84	65	75	90	1.5
U024530/R	Bend with sleeve, 30°	44.5	44.8	100	65	100	30	1.5
U024545/R	Bend with sleeve, 45°	44.5	44.8	100	65	100	45	1.5
U024560/R	Bend with sleeve, 60°	44.5	44.8	100	65	100	60	1.5
U024590/R	Bend with sleeve, 90°	44.5	44.8	100	65	100	90	1.5
U024830/R	Bend with sleeve, 30°	48.3	48.6	110	65	75	30	1.5
U024845/R	Bend with sleeve, 45°	48.3	48.6	110	65	75	45	1.5
U024860/R	Bend with sleeve, 60°	48.3	48.6	110	65	75	60	1.5
U024890/R	Bend with sleeve, 90°	48.3	48.6	110	65	75	90	1.5
U025130/R	Bend with sleeve, 30°	50.8	51.1	100	65	100	30	1.5
U025145/R	Bend with sleeve, 45°	50.8	51.1	100	65	100	45	1.5
U025160/R	Bend with sleeve, 60°	50.8	51.1	100	65	100	60	1.5
U025190/R	Bend with sleeve, 90°	50.8	51.1	100	65	100	90	1.5
U025430/R	Bend with sleeve, 30°	54.0	54.3	95	65	110	30	1.5
U025445/R	Bend with sleeve, 45°	54.0	54.3	95	65	110	45	1.5
U025460/R	Bend with sleeve, 60°	54.0	54.3	95	65	110	60	1.5
U025490/R	Bend with sleeve, 90°	54.0	54.3	95	65	110	90	1.5
U025730R*	Bend with sleeve, 30°	57.0	57.3	100	65	110	30	1.5
U025745R*	Bend with sleeve, 45°	57.0	57.3	100	65	110	45	1.5
U025760R*	Bend with sleeve, 60°	57.0	57.3	100	65	110	60	1.5
U025790R*	Bend with sleeve, 90°	57.0	57.3	100	65	110	90	1.5
U026030R*	Bend with sleeve, 30°	60.3	60.6	120	65	100	30	1.5
U026045R*	Bend with sleeve, 45°	60.3	60.6	120	65	100	45	1.5
U026060R*	Bend with sleeve, 60°	60.3	60.6	120	65	100	60	1.5
U026090R*	Bend with sleeve, 90°	60.3	60.6	120	65	100	90	1.5
U026330/R	Bend with sleeve, 30°	63.5	63.8	100	65	130	30	1.5
U026345/R	Bend with sleeve, 45°	63.5	63.8	100	65	130	45	1.5
U026360/R	Bend with sleeve, 60°	63.5	63.8	100	65	130	60	1.5
U026390/R	Bend with sleeve, 90°	63.5	63.8	100	65	130	90	1.5
U027030R*	Bend with sleeve, 30°	70.0	70.3	130	75	110	30	1.5
U027045R*	Bend with sleeve, 45°	70.0	70.3	130	75	110	45	1.5
U027060R*	Bend with sleeve, 60°	70.0	70.3	130	75	110	60	1.5
U027090R*	Bend with sleeve, 90°	70.0	70.3	130	75	110	90	1.5
U027630/R	Bend with sleeve, 30°	76.1	76.4	115	75	160	30	1.5
U027645/R	Bend with sleeve, 45°	76.1	76.4	115	75	160	45	1.5
U027660/R	Bend with sleeve, 60°	76.1	76.4	115	75	160	60	1.5
U027690/R	Bend with sleeve, 90°	76.1	76.4	115	75	160	90	1.5
U028930/R	Bend with sleeve, 30°	88.9	89.3	165	75	160	30	1.5
U028945/R	Bend with sleeve, 45°	88.9	89.3	165	75	160	45	1.5
U028960/R	Bend with sleeve, 60°	88.9	89.3	165	75	160	60	1.5
U028990/R	Bend with sleeve, 90°	88.9	89.3	165	75	160	90	1.5
U020230/R	Bend with sleeve, 30°	101.6	102.1	200	90	220	30	1.5
U020245/R	Bend with sleeve, 45°	101.6	102.1	200	90	220	45	1.5
U020260/R	Bend with sleeve, 60°	101.6	102.1	200	90	220	60	1.5
U020290/R	Bend with sleeve, 90°	101.6	102.1	200	90	220	90	1.5
U022730/R	Bend with sleeve, 30°	127.0	127.5	250	110	285	30	2.0
U022745/R	Bend with sleeve, 45°	127.0	127.5	250	110	285	45	2.0
U022760/R	Bend with sleeve, 60°	127.0	127.5	250	110	285	60	2.0
U022790/R	Bend with sleeve, 90°	127.0	127.5	250	110	285	90	2.0
	Tolerance	±0.1mm	±0.2mm	±5mm	±5mm	±2mm	±2°	±0.1mm

\*stainless steel only

**Over-axle Bends (1.75" to 3"):**

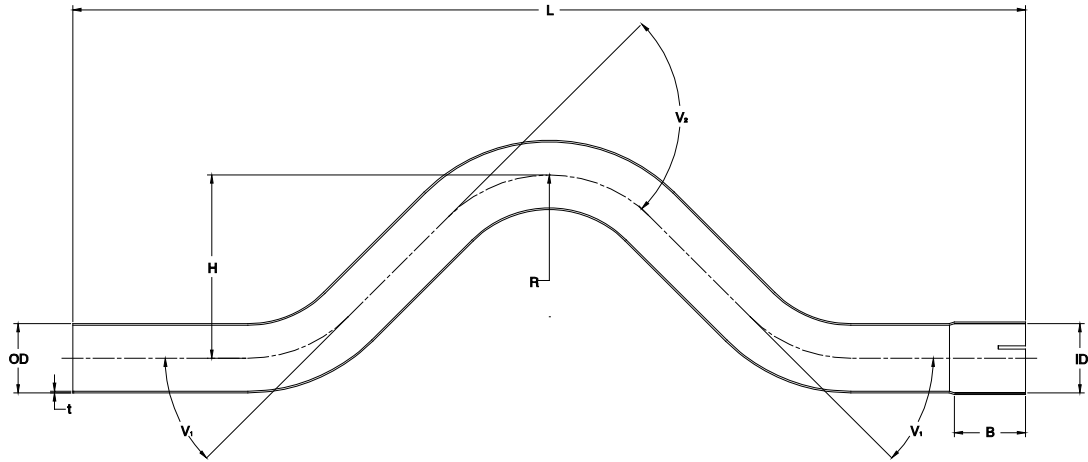

Part No.	Description	OD	ID	L	H	B	R	V1	V2	t
U044500/R	Over-axle	44.5	44.8	650	190	65	100	60	120	1.5
U045117/100R	Over-axle	50.8	51.1	660	185	65	100	60	120	1.5
U046321/300R	Over-axle	63.5	63.8	900	170	65	130	45	90	1.5
U047600/R	Over-axle	76.1	76.4	900	180	75	160	45	90	1.5
<i>Tolerance</i>		$\pm 0.1\text{mm}$	$\pm 0.2\text{mm}$	$\pm 10\text{mm}$	$\pm 5\text{mm}$	$\pm 5\text{mm}$	$\pm 2\text{mm}$	$\pm 2^\circ$	$\pm 2^\circ$	$\pm 0.1\text{mm}$

**180 Degree Bends (1.5" to 3"):**

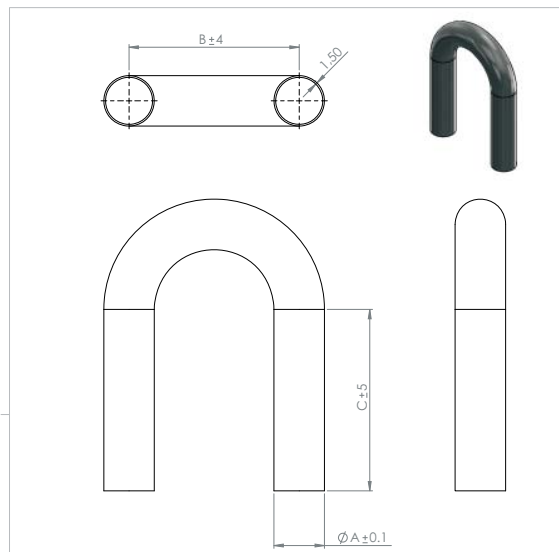

Part No.	Description	A (o/D)	B	C	CLR	t
U023818/R	Bend	38.0	120	76	60	1.5
U024218/R	Bend	42	150	84	75	1.5
U024518/R	Bend	44.5	150	160	75	1.5
U024818/R	Bend	48	150	96	75	1.5
U025118/R	Bend	50.8	170	160	85	1.5
U026018R*	Bend	60.3	200	120	100	1.5
U026318/R	Bend	63.5	200	160	100	1.5
U027618/R	Bend	76.1	240	160	120	1.5
<i>Tolerance</i>		$\pm 0.1\text{mm}$	$\pm 4\text{mm}$	$\pm 5\text{mm}$	$\pm 2\text{mm}$	$\pm 0.1\text{mm}$

\*stainless steel only

**Bends (tight) (1.5" to 5"):**

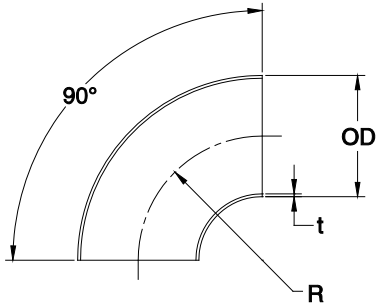

Part No.	Description	O/D	R	t
U033890/R	Tight bend 1.5"	38.0	42	1.5
U034590/R	Tight bend 1 3/4"	44.5	48	1.5
U035190/R	Tight bend 2"	50.8	52	1.5
U035790R*	Tight bend 2 1/4"	57.0	58	1.5
U036390/R	Tight bend 2 1/2"	63.5	63	1.5
U037090R*	Tight bend 2.75"	70.0	62	1.5
U037690/R	Tight bend 3"	76.1	62	1.5
U038990/R	Tight bend 3 1/2"	88.9	76	1.5
U030290/R	Tight bend 4"	101.6	85	1.5
U032790/R	Tight bend 4 1/2"	127.0	100	2.0
Tolerance		±2mm	±1mm	±0.1mm

\*stainless steel only

**T Pieces (2.5" to 3.5"):**

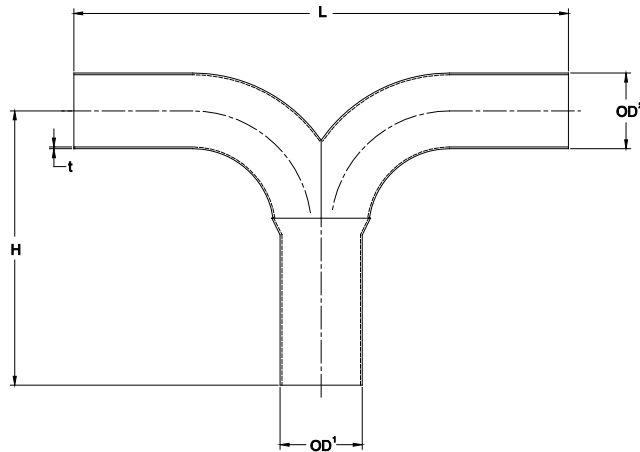

Part No.	Description	H	L	OD1	OD2	t
U916351/R	T Pipe	180	350	63.5	50.8	1.5
U916363/R	T Pipe	190	370	63.5	63.5	1.5
U917663/R	T Pipe	170	360	76.1	63.5	1.5
U917676R*	T Pipe	250	420	76.1	76.1	1.5
U918976R*	T Pipe	250	420	88.9	76.1	1.5
Tolerance		±20mm	±10mm	±0.2mm	±0.2mm	±0.1mm

\* stainless steel only

**Y Pieces (2" to 4"):**

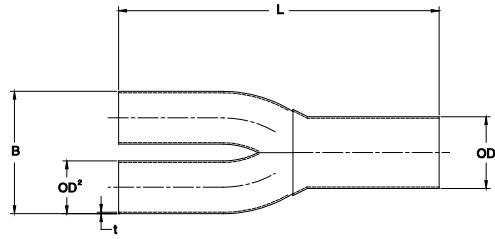

Part No.	Description	B	L	OD1	OD2	t
U905142^	Y Pipe 2"	95	320	50.8	42	1.5
U905145/R	Y Pipe 2"	100	320	50.8	44.5	1.5
U905151/R	Y Pipe 2"	115	325	50.8	50.8	1.5
U905745^	Y Pipe 2.25"	100	320	57	44.5	1.5
U905748^	Y Pipe 2.25"	110	320	57	48	1.5
U906348^	Y Pipe 2.5"	110	320	63.5	48	1.5
U906351/R	Y Pipe 2.5"	115	315	63.5	50.8	1.5
U906363/R	Y Pipe 2.5"	140	320	63.5	63.5	1.5
U907663/R	Y Pipe 3"	140	325	76.1	63.5	1.5
U907676R*	Y Pipe 3"	165	380	76.1	76.1	1.5
U908976R*	Y Pipe 3.5"	170	380	88.9	76.1	1.5
U900289R*	Y Pipe 4"	200	400	101.6	88.9	1.5
	Tolerance	±5mm	±10mm	±0.2mm	±0.2mm	±0.1mm

^ mild steel only  
\* stainless steel only

**X Pieces (2" to 3"):**

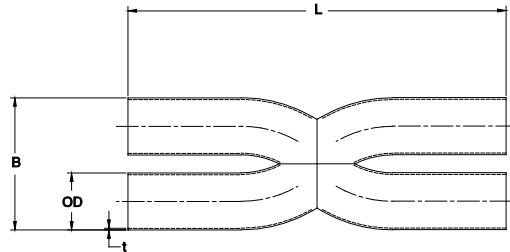

Part no.	Description	B	L	OD	t
U9051XR*	X Pipe	120	375	50.8	1.5
U9063XR*	X Pipe	140	380	63.5	1.5
U9076XR*	X Pipe	165	480	76.1	1.5

\* stainless steel only



### Double Ended Sleeves (1.75" to 5"):

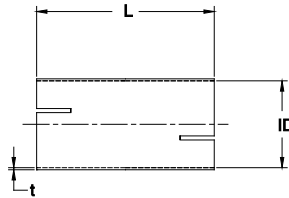

Part No.	Description	ID	L	t
U064500/R	Double-ended sleeve 44.5	44.8	100	1.5
U064800	Double-ended sleeve 48	48.3	100	1.5
U065120/100R	Double-ended sleeve 50.8	51.1	100	1.5
U066320/300R	Double-ended sleeve 63.5	63.8	150 <sup>++</sup>	1.5
U067620/600R	Double-ended sleeve 76.1	76.4	190 <sup>+++</sup>	1.5
U068900/R	Double-ended sleeve 88.9	89.3	190	1.5
U060200/R	Double-ended sleeve	102.1	220	1.5
U062700/R	Double-ended sleeve	127.5	260	2.0
<i>Tolerance</i>		$\pm 0.2\text{mm}$	$\pm 2\text{mm}$	$\pm 0.1\text{mm}$
		<sup>++</sup> Stainless version L=120mm		
		<sup>+++</sup> Stainless version L=150mm		

### Stepped Sleeves (1.75" to 5"):

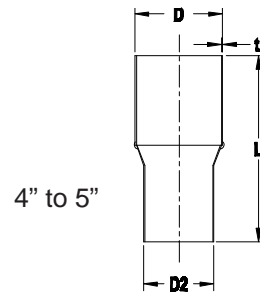
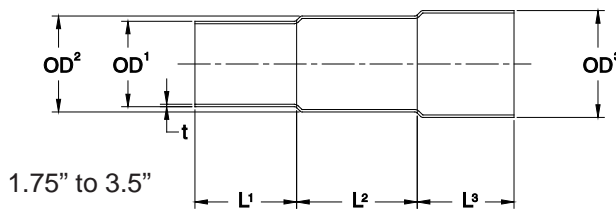

<sup>^</sup>slotted end  
I/D=101.6mm

Part No.	Description	OD1	OD2	OD3	L1	L2	L3	D	D2	L
U074500/R	(2 step) Stepped sleeve 38	42	44.5	50	50	60	-	-	160	
U075115/100R	(2 step) Stepped sleeve 41	48	50.8	40	55	65	-	-	160	
U076320/300R	(2 step) Stepped sleeve 50.8	57	63.5	60	75	55	-	-	190	
U077600/R	(2 step) Stepped sleeve 63.5	67	76.1	65	65	65	-	-	195	
U078900/R	(2 step) Stepped sleeve 76.1	80	88.9	65	65	65	-	-	195	
U070200/R	(1 step) Stepped sleeve -	-	-	-	-	-	101.6	88.9	200	
U070726	(1 step) Stepped sleeve -	-	-	-	-	-	105 <sup>^</sup>	76.1	140	
U072700/R	(1 step) Stepped sleeve -	-	-	-	-	-	127.0	101.6	270	
<i>Tolerance</i>		$\pm 0.2\text{mm}$	$\pm 0.2\text{mm}$	$\pm 0.2\text{mm}$	$\pm 5\text{mm}$	$\pm 5\text{mm}$	$\pm 5\text{mm}$	$\pm 5\text{mm}$	$\pm 5\text{mm}$	$\pm 5\text{mm}$

### Compensators (2" to 3"):

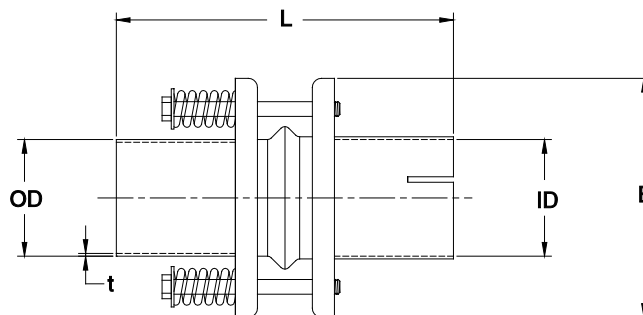

Part No.	Description	O/D	I/D	L	B	t
U055100	Compensator 51	50.8	51.1	200	135	1.5
U056300	Compensator 63	63.5	63.8	185	135	1.5
U057600*	Compensator 76	76.1	76.4	185	145	1.5
<i>Tolerance</i>		$\pm 0.1\text{mm}$	$\pm 0.2\text{mm}$	$\pm 5\text{mm}$	$\pm 5\text{mm}$	$\pm 0.1\text{mm}$

\* stainless-chromium steel only

**Flange Assemblies (2.5" to 3"):**

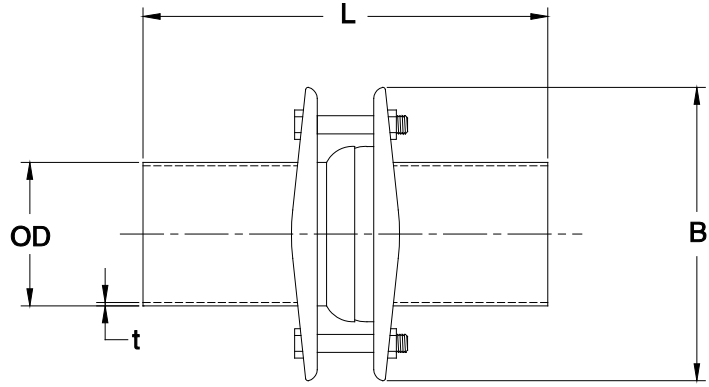

Part No.	Description	OD	L	B	t
U036301R*	Assembly 63	63.5	190	110	1.5
U037601R*	Assembly 76	76.1	190	130	1.5
	Tolerance	±0.2mm	±5mm	±5mm	±0.1mm

\* stainless steel only

**Decibel Reducers (2" to 3"):**

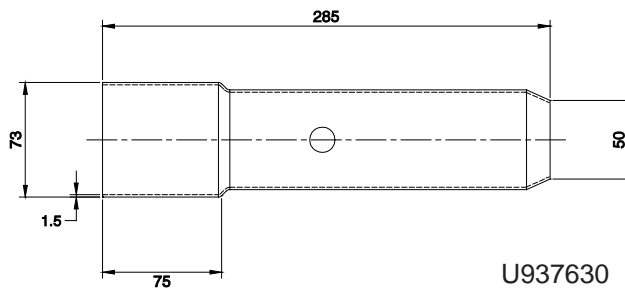
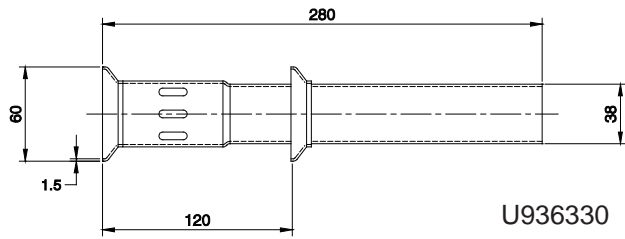
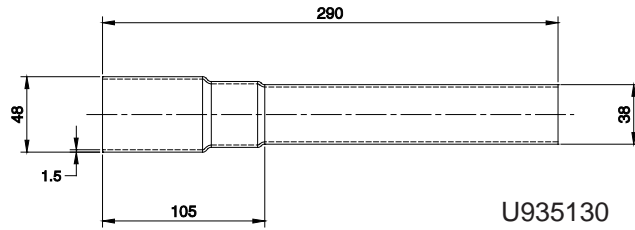

**Flanges (mild steel) (1.75" to 3"):**

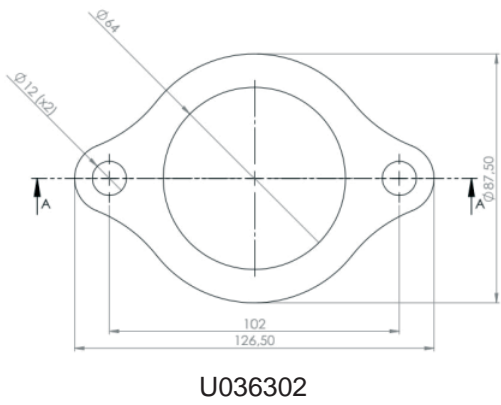
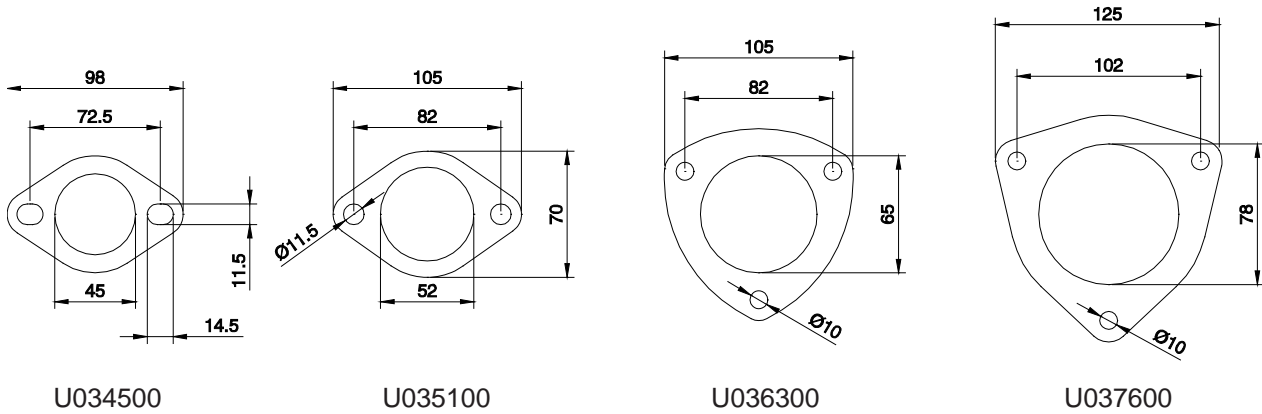

**Round Silencers (1.75" to 5"):**

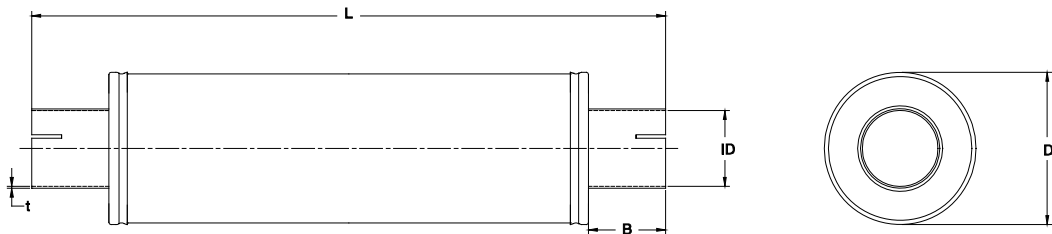

Part No.	Description	ID	L	B	t	D
U404500/R	Micro 45	44.8	530	65	1.5	80
U414500/R	Midi 45	44.8	550	65	1.5	100
U405120/R	Micro 51	51.1	530	65	1.5	80
U415129/100R	Midi 51	51.1	550	65	1.5	100
U446300/R	Tubex	63.8	755	65	1.5	100
U456300/R	Handy	63.8	380	65	1.5	125
U436337/300R	Slim	63.8	550	65	1.5	125
U447600/R	Turbex	76.4	755	65	1.5	125
U457600/R	Turbonett	76.4	380	65	1.5	125
U458900/R	Grandonett	89.3	400	75	1.5	140
U440200/R	Turbex XL	102.1	830	100	1.5	200
U430200/R	Grandonett XL	102.1	480	100	1.5	300
U442700/R	Turbex XXL	127.5	830	120	2.0	200
U432700/R	Grandonett XXL	127.5	480	120	2.0	300
	Tolerance	±0.2mm	±10mm	±5mm	±0.1mm	±3mm

### Oval Silencers (1.75" to 3.5"):

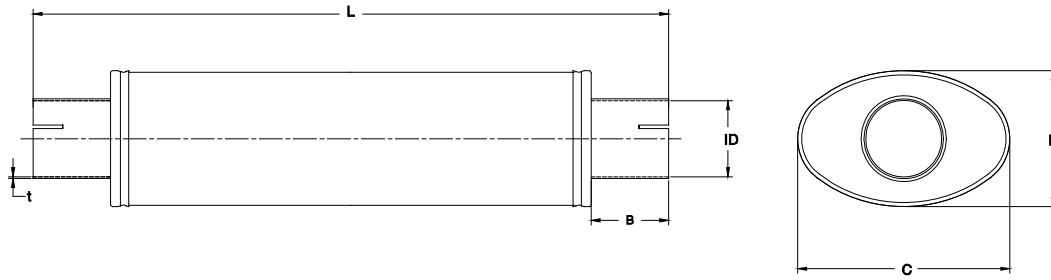

Part No.	Description	ID	L	B	t	H	C
U334500/R	Medium 45	44.8	550	65	1.5	100	165
U355124/100R	Small	51.1	450	65	1.5	100	165
U335139/100R	Medium 51	51.1	550	65	1.5	100	165
U325100/R	Big 51	51.1	550	65	1.5	115	185
U316335/300R	Super	63.8	450	65	1.5	115	185
U326340/300R	Big 63	63.8	550	65	1.5	115	185
U336300/R	Heavy	63.8	630	65	1.5	140	220
U307600/R	Turbotight	76.4	380	65	1.5	140	220
U337600/R	Turbolight	76.4	550	65	1.5	140	220
U327600/R	Turbo*	76.4	630	65	1.5	140	220
U328900/R	Grand	89.3	650	75	1.5	140	220
U308900/R	Grandotight	89.3	400	75	1.5	140	220

Tolerance                    ±0.2mm    ±10mm    ±5mm    ±0.1mm    ±3mm    ±3mm

\*One of the sleeves is off centre by 50mm

### Oval 1 in 2 out Silencers (2.5" to 3"):

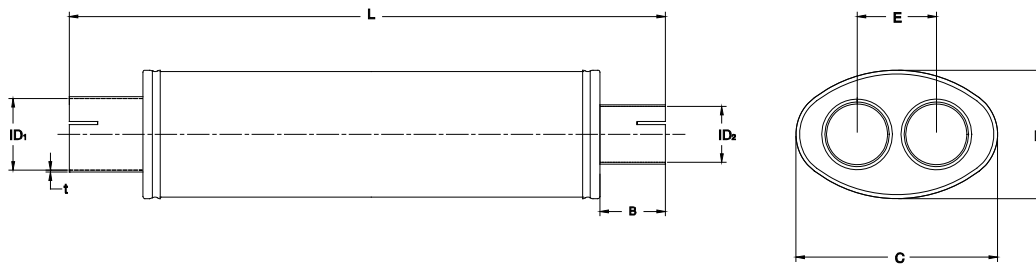

Part No.	Description	ID1	ID2	L	B	t	H	C	E
U346351/R	Split 63	63.8	51.1	450	65	1.5	115	185	80
U347663/R	Split 76	76.4	63.8	450	65	1.5	140	220	100

Tolerance                    ±0.2mm    ±0.2mm    ±10mm    ±5mm    ±0.1mm    ±3mm    ±3mm    ±3mm

### Oval 2 in 2 out Silencers (Stainless Steel Only) (2" to 3"):

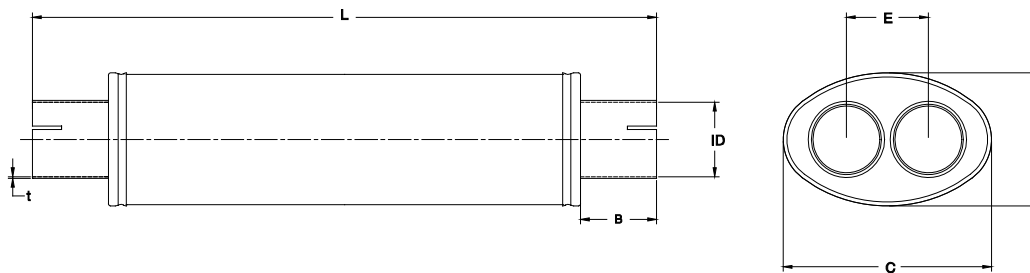

Part No.	Description	ID	L	B	t	H	C	E
U3451DR	Duo 51	51.1	450	65	1.5	115	185	75
U3463DR	Duo 63	63.8	450	65	1.5	115	185	80
U3476DR	Duo 76	76.4	450	65	1.5	140	220	95

Tolerance                    ±0.2mm    ±10mm    ±5mm    ±0.1mm    ±3mm    ±3mm    ±3mm



**Oval Transverse Duplex Silencers (Stainless Steel Only) (2.5" to 3"):**

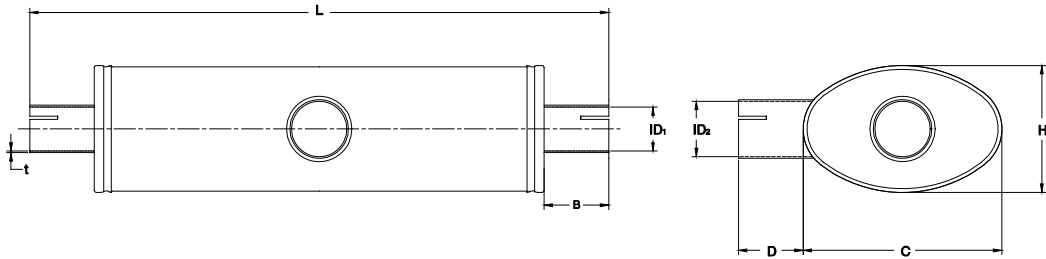

Part No.	Description	ID1	ID2	L	B	t	H	C	D
U326351R	Duplex 63-51	51.1	63,8	630	65	1.5	140	220	65
U327663R	Duplex 76-63	63.8	76.4	630	65	1.5	140	220	65
	<i>Tolerance</i>	$\pm 0.2mm$	$\pm 0.2mm$	$\pm 10mm$	$\pm 5mm$	$\pm 0.1mm$	$\pm 3mm$	$\pm 3mm$	$\pm 3mm$

**Tailpipes (1.75" to 3.5"):**

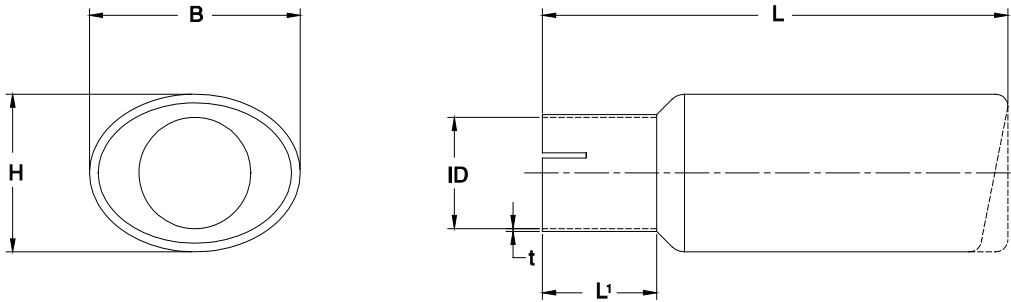

Part No.	Description	ID	L	L1	t	H	B	Type
U254500	Rondo 45	45,8	260	30	1,5	70	70	Round
U235100	Ellips 51	51.1	235	65	1.5	70	90	Oval
U255100	Rondo 51	51.1	275	65	1.5	70	70	Round
U255110	Rondo XL 51	51.1	265	65	1.5	100	100	Round
U236300	Ellips 63	63.8	275	65	1.5	70	90	Oval
U23630L	Ellips 63 Left	63.8	230	65	1.5	90	120	Oval
U23630R	Ellips 63 Right	63.8	230	65	1.5	90	120	Oval
U236310	Ellips XL 63	63.8	255	65	1.5	90	120	Oval
U236320	Superior 63	63.8	260	65	1.5	90	140	Oval
U246300	Quattro 63	63.8	265	65	1.5	70	90	Square Oval
U256300	Rondo 63	63.8	275	65	1.5	80	80	Round
U256310	Rondo XL 63	63.8	265	65	1.5	100	100	Round
U266300	Bold 63	63.8	245	65	1.5	85	150	Flat Oval
U237600	Ellips 76	76.4	270	65	1.5	90	120	Oval
U237620	Superior 76	76.4	260	65	1.5	90	140	Oval
U257600	Rondo 76	76.4	245	65	1.5	100	100	Round
U257610	Rondo XL 76	76.4	255	65	1.5	114	114	Round
U267600	Bold 76	76.4	245	65	1.5	85	150	Flat Oval
U258910	Rondo XL 89	89.3	260	65	1.5	114	114	Round
	<i>Tolerance</i>	$\pm 0.2mm$	$\pm 5mm$	$\pm 5mm$	$\pm 0.1mm$	$\pm 2mm$	$\pm 2mm$	

**Weldable Tailpipes (2.5"):**

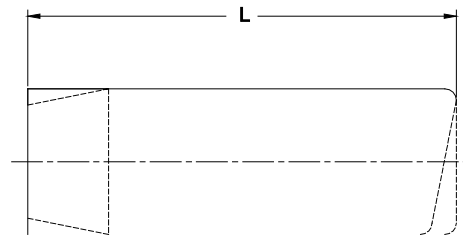
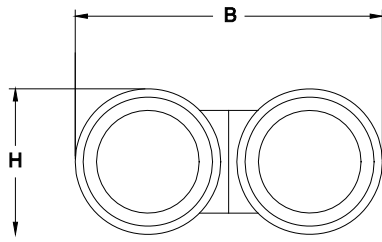

**Part No.**  
U176300

**Description**  
Twin 'Rondo'  
*Tolerance*

<b>L</b>	<b>H</b>	<b>B</b>
240	80	170
<i>±5mm</i>	<i>±2mm</i>	<i>±5mm</i>